



⚠️ WARNING: Avoid serious injury or death to your child. Never use your MyFit Zip Air Child Restraint without the softgoods in place. You must read and understand the Softgood Removal instructions and the instructions in the User Guide. If you do not understand these instructions, **DO NOT** attempt to remove the softgoods, **STOP and call Chicco at 1-877-424-4226.** SS0017E_01

INSTRUCTIONS: MyFit Zip Air Softgoods Removal/Installation

IMPORTANT: Please also refer to the instructions that came with your product.

SOFTGOODS REMOVAL:

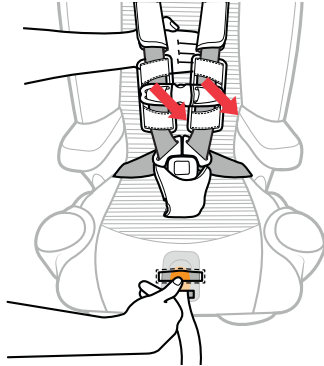

1 Completely loosen Harness by pressing Harness Release Button on the front of the Child Restraint and pulling out on both of the Harness Straps. Then unbuckle the Chest Clip and Harness Buckle.

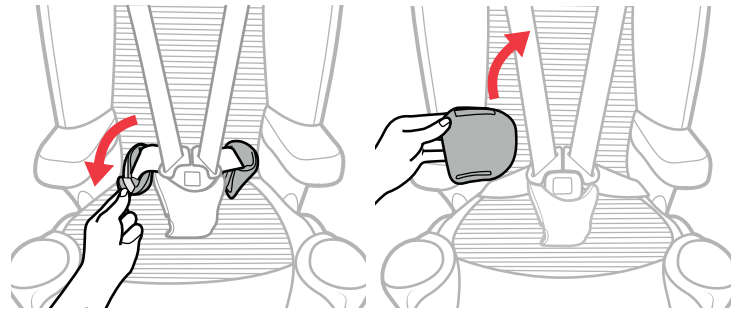

2 Undo the hook and loop fastener on BOTH Waist Belt pads and remove.

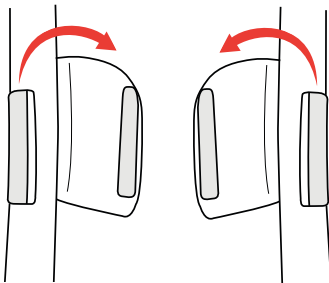

3 Unhook the hook and loop Tab and remove BOTH Shoulder Pads.

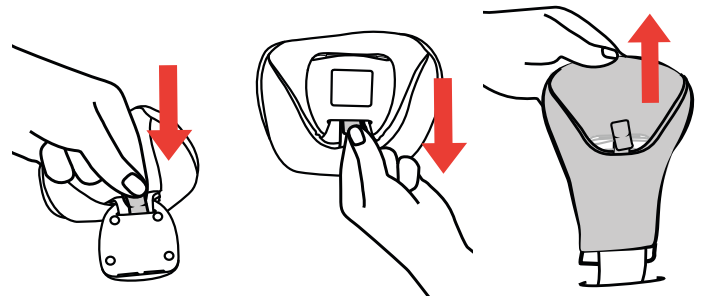

4 Remove the Crotch Strap Pad by pushing the fabric Tab through the slot on the **BACK** of the Harness Buckle. Then pull the Tab out of the **FRONT** and remove Crotch Strap Pad.

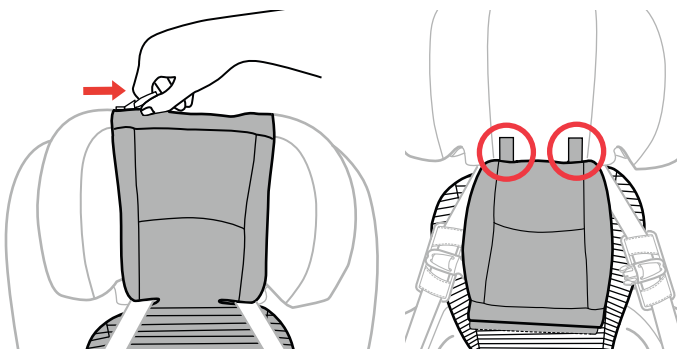

5 Remove the Seat Back Air Mesh pad by unzipping the pad at the top of the headrest. Then unhook both hook and loop tabs near the Shoulder Belt Guides.

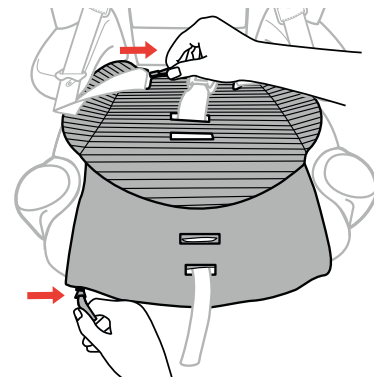

6 Remove the Seat Bottom Air Mesh pad by unzipping the pad at the back and front of the seat bottom. Thread the Crotch Strap down through the fabric and remove the Air Mesh Pad.

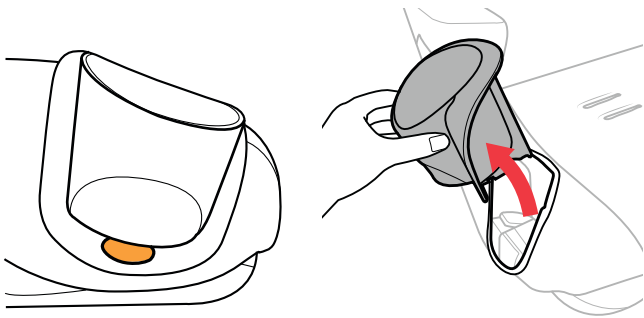

7 Remove **BOTH** of the cup holders by pressing the orange button located on the bottom edge of the Cup Holder and lifting up.

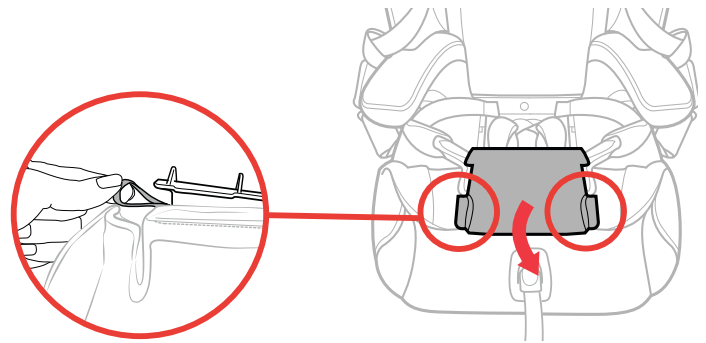

8 Lift up on the Seat Bottom Pad, undo both elastic straps attached to the Latch Storage Compartment. Close the Compartment door.

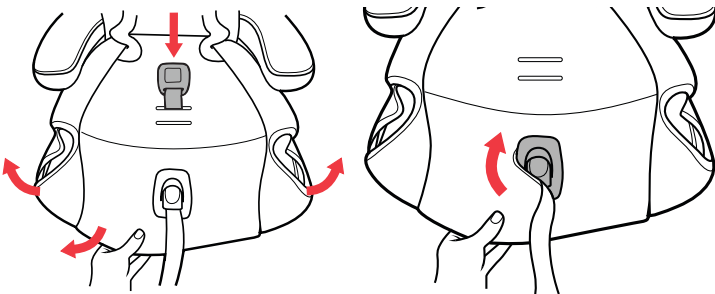

9 Thread the Crotch Strap down through the fabric and pull the **FABRIC** up around the front and sides of the seat. Then pull fabric around the Harness Adjuster Strap Cover and remove the Seat Bottom Pad. The plastic Harness Adjuster Strap Cover is **NOT** removable.

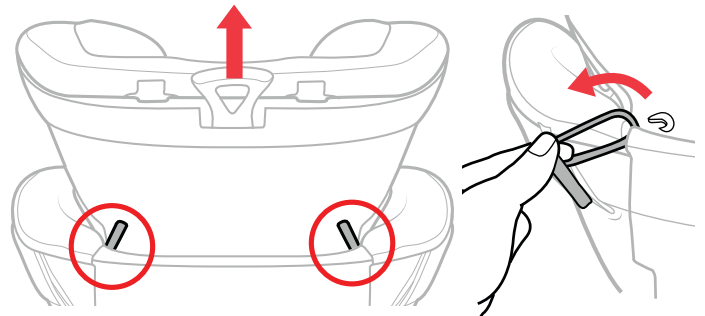

10 With the Headrest in the highest position, locate the elastic strap on the **BACK** of the Headrest and unhook by pulling up on the fabric tab. Repeat this step for the other elastic strap.

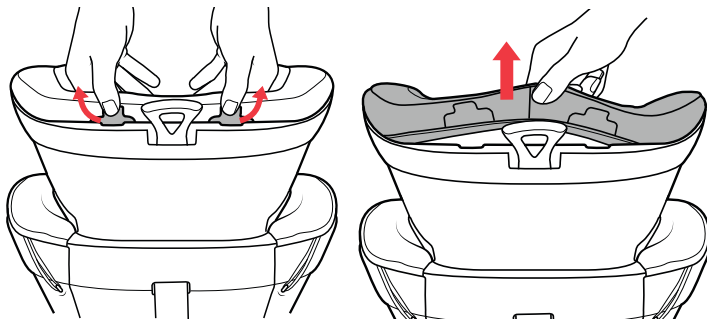

11 Pull back gently on both of the plastic tabs at the top of the Headrest and pull up on the Headrest fabric.

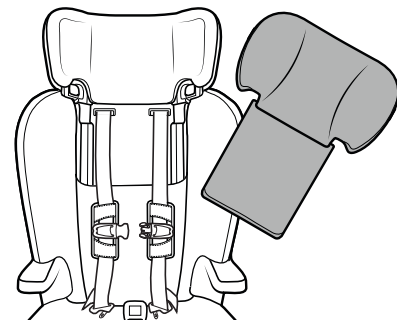

12 Remove the Headrest Fabric Pad, as shown.

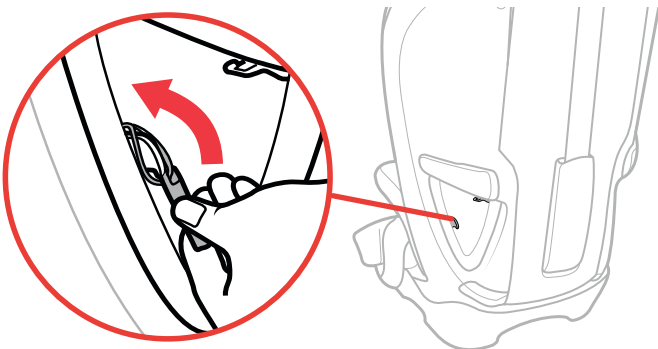

13 Unhook the Armrest fabric loop from the side hook located near the vehicle belt path. Repeat this step for the other side. **TIP:** To Assist in the removal of the Armrest fabric, push back on the fabric while removing the loop.

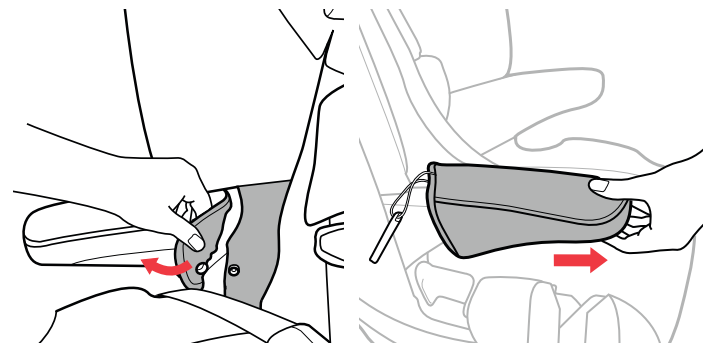

14 Undo the snap attaching the Armrest Fabric to the Backrest Seat Pad and then remove the Armrest Fabric. Repeat this step for the other Armrest.

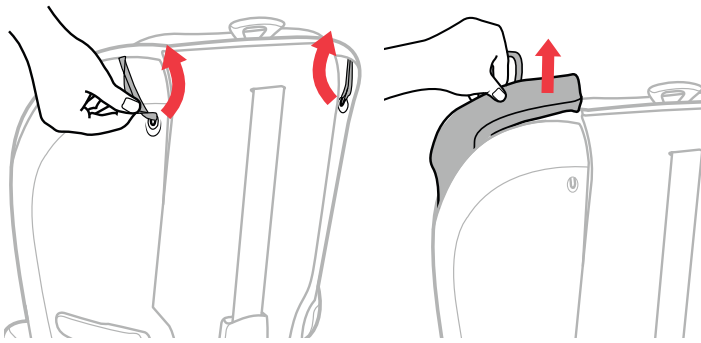

15 **Unhook BOTH elastic straps** on the back of the Child Restraint. Pull the fabric out gently from the groove around the Child Restraint. Repeat for the other side.

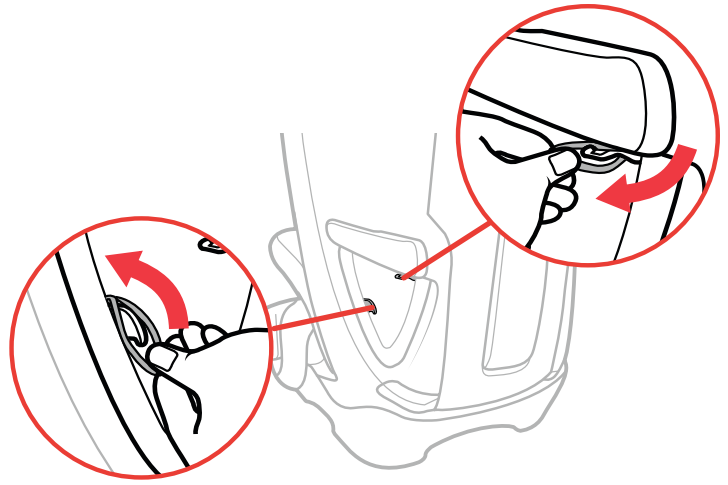

16 **Unhook the elastic strap** from the side hook and the top hook located near the vehicle belt path. Repeat for the other side.

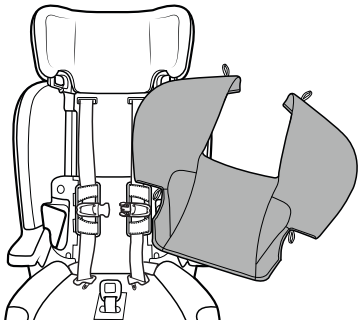

17 **Remove the Backrest Seat Pad** from the Child Restraint.
NEVER use Child Restraint without the Seat Pad.

Cleaning Instructions:

Fabrics may be hand washed using mild soap and water, or machine washed in cold water on delicate cycle using mild detergent. Hang to dry. **DO NOT BLEACH.** Please consult your product manual for additional care and maintenance instructions.

DO NOT remove the Harness Straps, Chest Clip, and Chest Clip pads. The Chest Clip Pads can be easily spot cleaned with warm water and mild soap. Contact Chicco Customer Service at **1-877-424-4226** for assistance or additional information.

CROTCH STRAP REMOVAL:

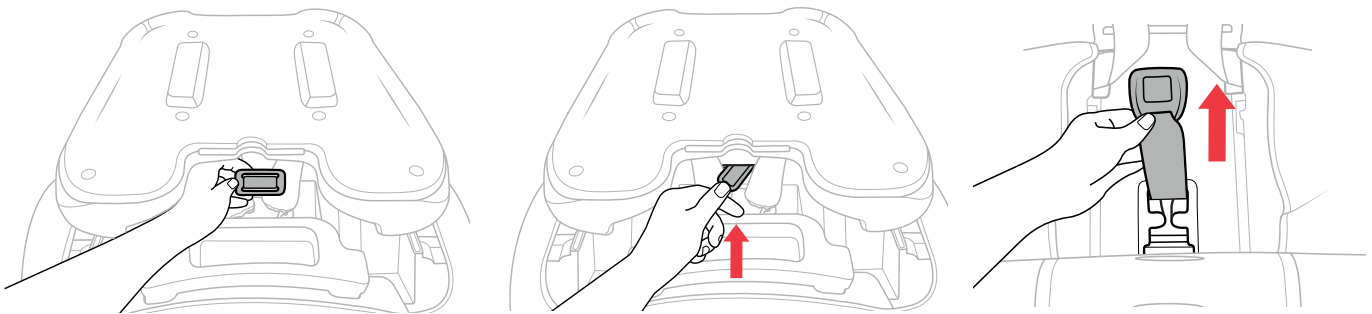

18 **Fully recline the seat (position 1).** Turn the Child Restraint over and locate the crotch strap metal bar. Turn metal bar slightly and get corner to go through slot. Push metal bar through slot while pulling crotch belt out.

NEVER use Child Restraint without the Crotch Strap installed.

CROTCH STRAP INSTALLATION:

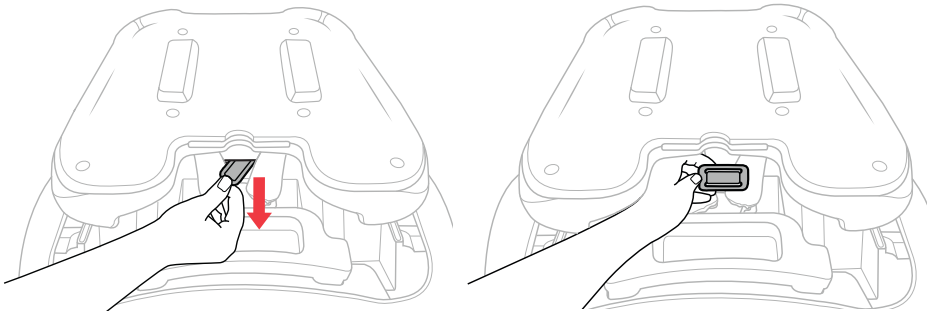

19 Push the metal bar through slot on top of the Child Restraint seat and pull through the other side. Turn the metal bar so that it lays flat on the bottom of the seat.

NEVER use Child Restraint without the Crotch Strap installed.

KIDCONSOLE:

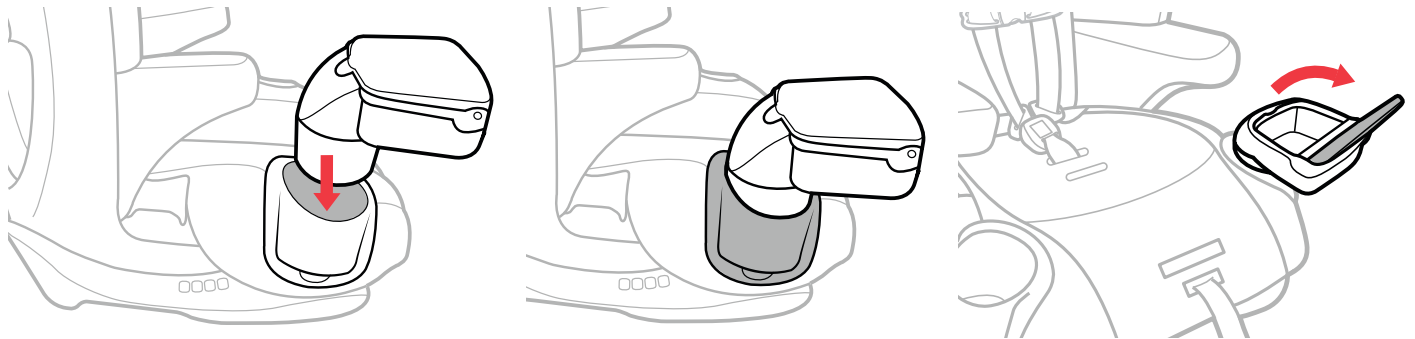

20 **Insert the console** into either of the cup holders, as shown. The KidConsole base should fit entirely inside of the cup holder. Do not force the console into the cup holder. Make sure the console fits snugly into the cup holder before use. Lift up on the tab to open the console, as shown.

WARNING - Do NOT place liquids in console. Do NOT place more than 1lb in the console.

SOFTGOODS INSTALLATION:

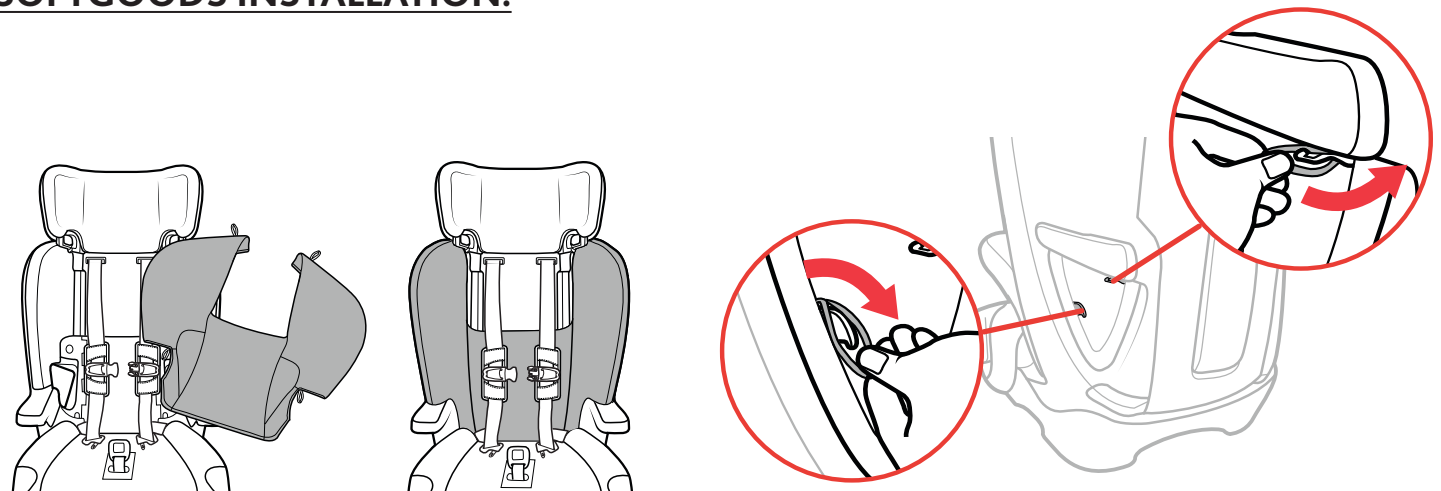

1 **Place the Backrest Seat Pad** onto the Child Restraint.

2 **Hook the elastic strap** onto the side hook and the top hook located near the vehicle belt path. Repeat for the other side.

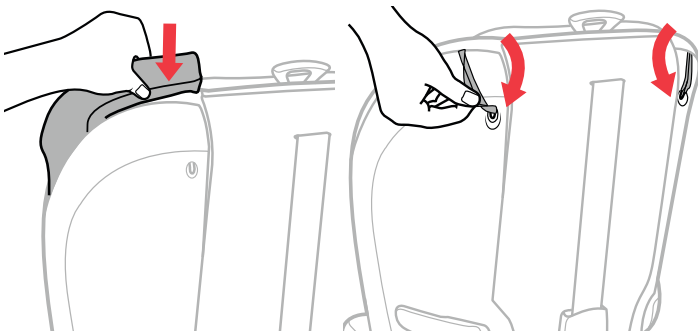

3 Tuck the fabric into the groove gently around the Child Restraint. Repeat for the other side. Hook BOTH elastic straps onto the back of the Child Restraint.

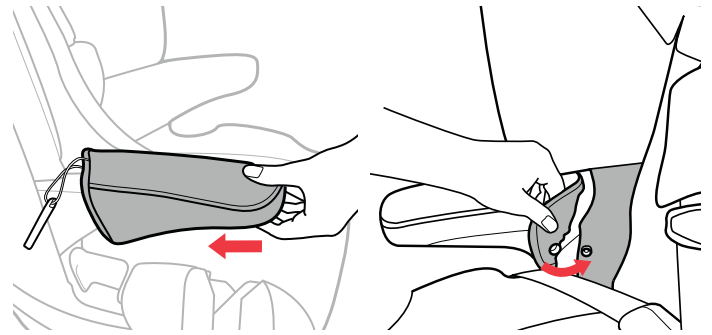

4 Slide the Armrest Fabric onto the armrest then snap the Armrest Fabric to the Backrest Seat Pad. Repeat this step for the other Armrest.

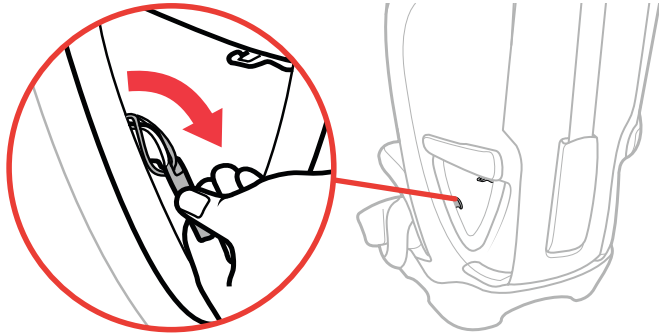

5 Hook the Armrest fabric loop onto the side hook located near the vehicle belt path. Repeat this step for the other side. **TIP:** To Assist in the attachment of the Armrest fabric, push back on the fabric while hooking the loop.

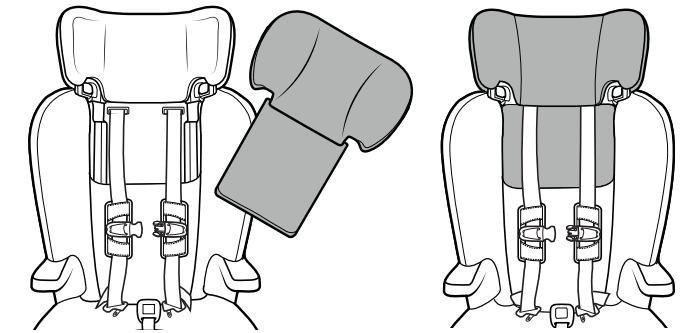

6 Place the Headrest Fabric Pad onto the Headrest.

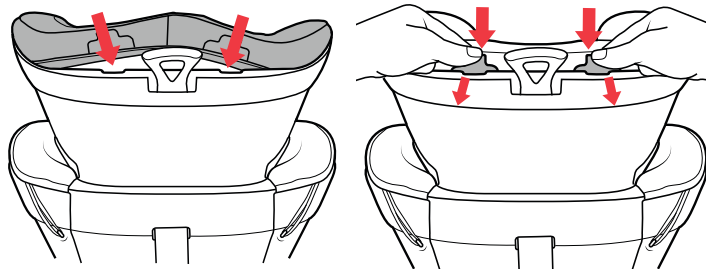

7 Tuck the fabric into the groove at the top of the headrest. Push down gently on both of the plastic tabs at the top of the Headrest until they snap into the grooves.

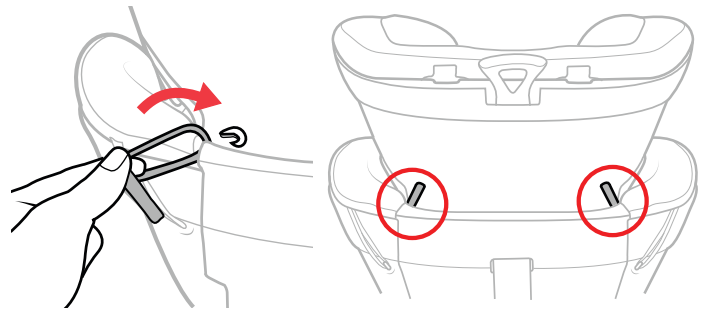

8 With the Headrest in the highest position, hook the elastic strap onto the **BACK** of the Headrest. Repeat this step for the other elastic strap.

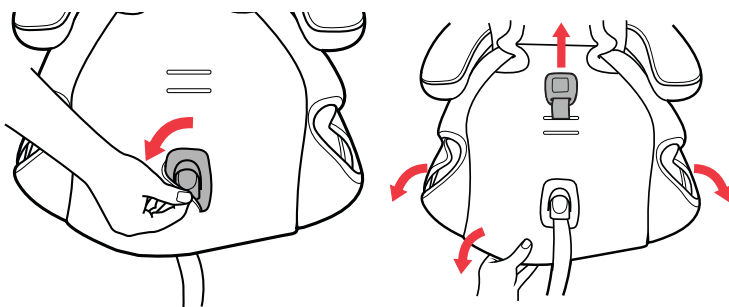

9 Place the Seat Bottom Fabric onto the Child Restraint and pull fabric around the Harness Adjuster Strap Cover. Then pull the Crotch Strap UP through the fabric and pull the FABRIC down and around the front and sides of the seat.

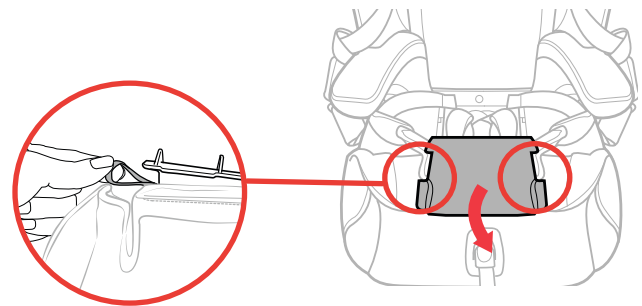

10 Lift up on the Latch Storage Compartment door, wrap both elastic straps on the Seat Bottom Pad around each end of the Latch Storage Compartment door, as shown. Close the Compartment door.

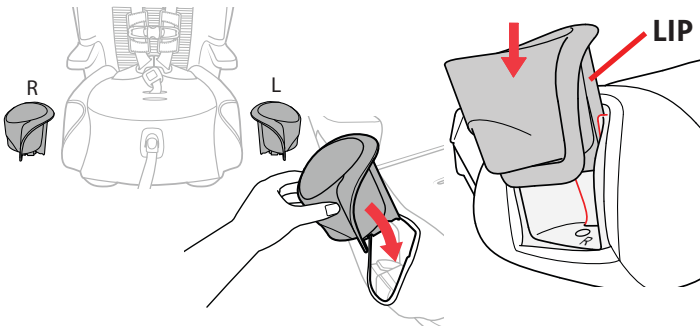

11 Match the "R" and "L" Cup Holders to the Child Restraint, and insert the Cup Holder. Make sure the Lip fits behind the groove and it clicks into place. Repeat this step for the other Cup Holder.

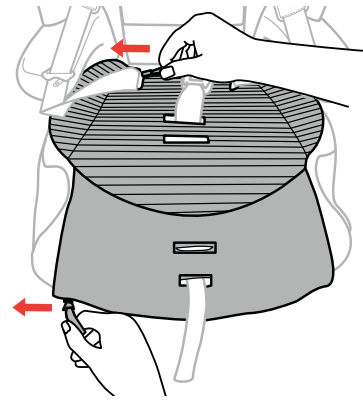

12 Re-attach the Seat Bottom Air Mesh pad, thread the crotch strap through the correct opening in the pad. Then zip the pad at the back and front of the Seat Bottom Air Mesh pad.

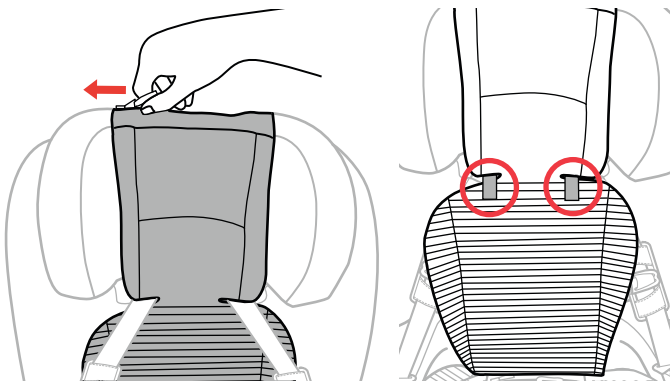

13 Re-attach the Seat Back Air Mesh pad by zipping the pad at the top of the headrest. Then attach both hook and loop tabs to the underside of the Headrest fabric below the Air Mesh pad.

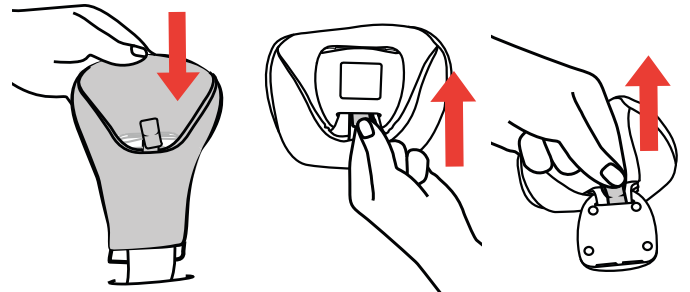

14 Replace the Crotch Strap Pad by sliding the Harness Buckle up through the Crotch Strap Pad. Then push the fabric Tab through the slot on the **FRONT** of the Harness Buckle. Then pull the Tab out of the **BACK** to secure it.

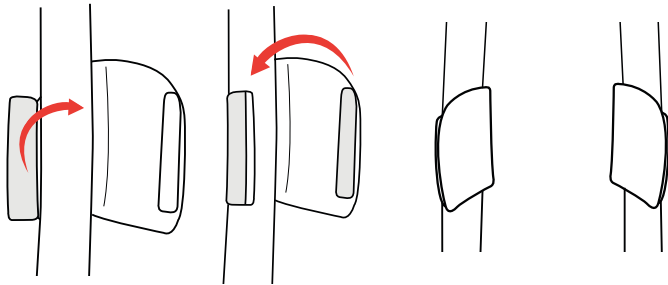

15 Re-attach Shoulder Pad by folding the hook and loop Tab over the Harness Strap. Secure both hook and loop sides together. Repeat for the other Shoulder Pad and make sure they are oriented, as shown.

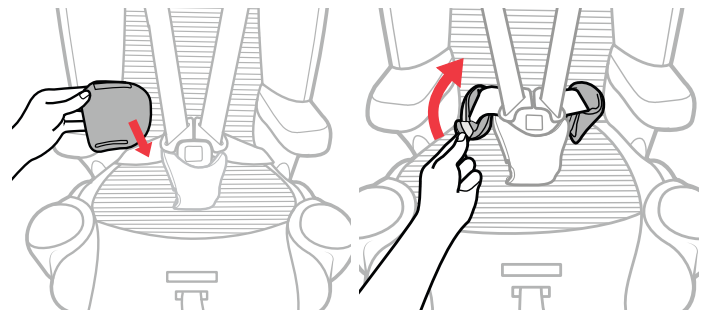

16 To attach the both Waist Belt pads, wrap one of the pads around the Harness Waist Strap and attach the hook and loop fasteners, repeat for the other Waist Belt pad.