



# FIT360™

## Rotating Convertible Car Seat

For future use, store user guide  
in compartment at front of base.

IS0224E\_04 02/24 ©2024 Artsana USA, Inc.  
[ChiccoUSA.com](http://ChiccoUSA.com)



## *User Guide*

If you have any problems with your Chicco Child Restraint, or any questions regarding installation or use, please call:

**Chicco Customer Service**  
**1-877-424-4226**

Please have Model and Serial Number available when you call. These are located on a label on the base of the Child Restraint.

For future reference, fill in the information below. The information can be found on the label on the bottom of the Child Restraint.

Model Number: \_\_\_\_\_

Serial Number: \_\_\_\_\_

Manufactured In: \_\_\_\_\_

## TABLE OF CONTENTS

Registration and Recall	2	<b>BASE INSTALLATION</b>	
Child Guidelines	4	Base Install	50
Safe Use Checklist	6	Install Using <b>LAP-SHOULDER BELT</b>	58
Important Warnings	8	Install Using <b>LATCH</b>	64
Best Practices	14	Install Using <b>LAP BELT ONLY</b>	72
Need Help?	15		
<b>CHILD RESTRAINT OVERVIEW</b>			
Child Restraint Components	16	<b>REAR-FACING INSTALLATION</b>	
LATCH and Tether Components	20	Rear-Facing Setup	78
LATCH and Tether Storage	22		
Selecting Rear/Forward Facing Position	24	<b>FORWARD-FACING INSTALLATION</b>	
Removing Flex-Forward Crotch Pad	28	Forward-Facing Setup	82
Adjusting Crotch Strap	32		
Newborn Head and Body Positioner	36	<b>SECURING YOUR CHILD</b>	
Install Flex-Forward Crotch Pad	40	Securing Child with Harness	86
		Secure Child Checklist	100
<b>VEHICLE INFORMATION</b>			
Vehicle Seating Positions	42	<b>ADDITIONAL INFORMATION</b>	
Vehicle Seat Belts	44	Installation on an Aircraft	102
What is LATCH?	46	Cup Holder	106
What is a Tether?	48	Cleaning and Maintenance	108

Please complete the Registration Card that came with your Child Restraint and mail it promptly.

Child Restraints could be recalled for safety reasons. You must register this restraint to be reached in a recall. Send your name, address, e-mail address if available, and the restraint's model number and manufacturing date to:

**Artsana USA, Inc.**  
**1826 William Penn Way**  
**Lancaster, PA 17601**  
or call 1-877-424-4226

or register online at <http://www.chiccousa.com/carseatregistration.aspx>

For recall information, call the U.S. Government's Vehicle Safety Hotline at 1-888-327-4236 (TTY: 1-800-424-9153), or go to [www.NHTSA.gov](http://www.NHTSA.gov).

PAGE INTENTIONALLY LEFT BLANK

## CHILD GUIDELINES

This Child Restraint is designed for children ages Birth to 6 years old. **ONLY** use this Child Restraint if the child meets **BOTH** of the following Weight and Height requirements:

- **Weight is between 4 and 65 pounds (1.8 and 29.5 kg).**
- **Height is 49 inches (125 cm) or less.**

The Newborn Head and Body Positioner is only for infants who weigh between 4 and 11 pounds (1.8 and 5 kg). See Newborn Head and Body Positioner on page 36.

⚠ For premature infants, you must consult the infant's doctor before using this Child Restraint. A premature infant may have difficulty breathing or have other medical problems when placed in a seated position.

## CHILD GUIDELINES

See Select Rear-Facing on page 24.

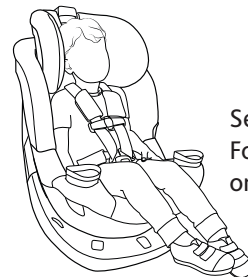
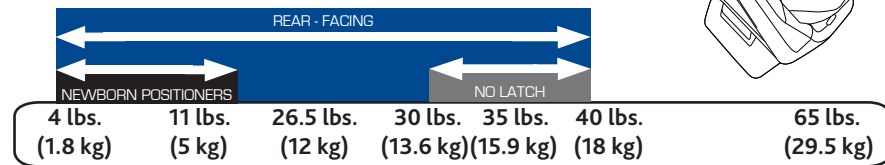
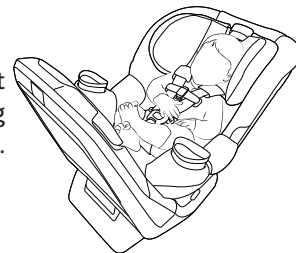

See Select Forward-Facing on page 26.

## SAFE USE CHECKLIST

**⚠ YOUR CHILD'S SAFETY DEPENDS ON YOU!** You MUST follow the detailed instructions in this User Guide to ensure the steps below are performed correctly!

- Make sure your child meets the age, weight, and height requirements:**  
Refer to the "Child Guidelines" section on page 4.

- Choose the proper Child Restraint configuration:**

**REAR-FACING** requirements on page 24

**FORWARD-FACING** requirements on page 26

- Select a safe seating location in your car:**  
Refer to the "Vehicle Seating Positions" section on page 42 and 43.



## SAFE USE CHECKLIST

- Ensure that the Child Restraint is properly leveled when installed:**

**BASE INSTALL** requirements on page 50.

- Check Child Restraint for a snug fit in your car:**  
While holding Child Restraint near belt path, pull side to side and forward. Belt should remain tight and Child Restraint should not move more than 1" (25 mm) from vehicle seat back or side-to-side.

- Secure your child:**  
Refer to the "Securing Your Child" section on page 86.

- Check Seat is locked into position (even when unoccupied):**

**REAR-FACING SETUP** on page 78

**FORWARD-FACING SETUP** on page 82



**FAILURE TO FOLLOW THESE INSTRUCTIONS AND THE PRODUCT LABELS CAN RESULT IN SERIOUS INJURY OR DEATH TO YOUR CHILD.**

### Take Time to Read This User Guide

- Carefully read and understand all instructions and warnings in this User Guide. Your child's safety depends on you knowing how to setup, install and use this Child Restraint properly.
- Before installing this Child Restraint in a vehicle, be sure to also check the vehicle owner's manual for information on proper installation.
- **NEVER** allow others to use this Child Restraint until they have read and understood all instructions in this User Guide.
- This Child Restraint is not intended for use outside of the vehicle.
- Do not install or use seat in vehicle without base.

### Make Sure Child Fits This Child Restraint

- Use only with children who weigh between 4 lbs (1.8 kg) and 65 lbs (29.5 kg) and whose height is 49 inches (125 cm) or less. Determine the right installation setup for your child's age, weight and height.
- **ONLY USE** the Newborn Head and Body Positioner REAR-FACING and only if the child weighs between 4 and 11 lbs (1.8 and 5 kg).



### Secure Child Properly

- Snugly adjust the harness around your child. A loose harness could cause the child to be ejected in a sudden stop or crash, resulting in serious injury or death.

A snug strap should not allow any slack. It lies in a relatively straight line without sagging. It does not press on the child's flesh or push the child's body into an unnatural position.

- **NEVER** use clothing or blankets that interfere with fastening or tightening the harness. An unsecured child could be ejected in a sudden stop or crash!

To keep child warm, place a blanket over child and restraint AFTER you have properly secured child in harness.

- **ALWAYS** check to make sure buckle is securely latched. If buckle separates, child could be killed or seriously injured.
- **NEVER** leave child unattended. Do not allow children to play in or around the Child Restraint.
- **ALWAYS** keep child properly secured in harness whenever child is in Child Restraint.
- **NEVER** remove or carry seat with child in it.



### Install Child Restraint Correctly

- **WHEN USING THIS CHILD RESTRAINT REAR-FACING, DO NOT PLACE THIS CHILD RESTRAINT IN VEHICLE SEATING LOCATION WITH A FRONTAL AIR BAG, UNLESS THE AIR BAG CAN BE TURNED OFF.** If the airbag inflates, it can cause serious injury or death to your child. For vehicles with side air bags, refer to your vehicle owner's manual for information on your child restraint installation.
- **ALWAYS** install this Child Restraint in a back seat if possible.

According to accident statistics, children are safer when properly restrained in the rear seating positions rather than in the front seating positions.

- **NEVER** install on a rear-facing or side-facing vehicle seat, or on the back of a folded down vehicle seat.
- **ALWAYS** secure this Child Restraint with the vehicle's child restraint anchorage system (LATCH) if available OR the vehicle seat belt. Refer to Page 5 for proper use/child weight limits when installing with LATCH.
- **DO NOT** use the lower anchors of the child restraint anchorage system (LATCH system) to attach this Child Restraint **REAR-FACING** when restraining a child weighing more than **30 lbs (13.6 kg)** or **FORWARD-FACING** when restraining a child weighing more than **35 lbs (15.9 kg)**.



### Install Child Restraint Correctly

- **ALWAYS** use the top tether strap on this child restraint, if a tether anchor is available.
- **NEVER** use Child Restraint in a vehicle seating position where it cannot be secured tightly. A loosely installed Child Restraint will not protect your child in a crash.
- **Never leave Child Restraint unsecured in your vehicle even when it is unoccupied.** It could injure other occupants in a sudden stop or crash.
- **DO NOT** install this Child Restraint using an inflatable seat belt. The interaction of the inflatable portion of the vehicle's belt with this Child Restraint **can result in serious injury or death.** Install using LATCH instead, or move the car seat to a position with a suitable seat belt type.

### Ensure Child's Safety When Using Child Restraint

- **NEVER leave your child unattended in the vehicle.**
- **STRANGULATION HAZARD:** Your child can strangle in a loose Restraint Harness. Never leave a child in the Child Restraint with straps loose or undone.
- To **prevent ejection or breathing difficulties, proper recline is required.** When installing the Child Restraint, check the bubble level on the Base of the Child Restraint.



### Check Condition of Restraint

- **DO NOT** use if the Harness or LATCH straps are cut, frayed or damaged.
- **DO NOT use this Child Restraint if it is more than 8 years old.** Check manufacturer's label on Base of Child Restraint for the "Do Not Use After" date.
- **DO NOT use any accessories, pads or products not included with this Child Restraint, unless approved by Chicco USA.** Doing so will void the warranty of this Child Restraint.
- **You MUST replace this Child Restraint if it has been involved in a crash, even if you cannot see visible damage.** A damaged Child Restraint may not protect your child in a future crash.
- **Do not modify your Child Restraint.**
- **NEVER** remove harness from Child Restraint. For proper removal and installation of the harness straps contact Chicco USA for additional instructions.
- **Do not use Child Restraint if any component is damaged, broken, or missing parts.** Call 1-877-424-4226 to find out if the damaged part or parts can be replaced.

PAGE INTENTIONALLY LEFT BLANK



- Ensure all vehicle occupants are properly restrained before traveling. Unrestrained occupants can be thrown around and may be seriously injured or seriously injure other occupants in a sharp turn, sudden stop or crash.
- Do not leave loose objects, such as books, bags, etc., in the back of the vehicle. In the event of a sharp turn, sudden stop, or crash, loose objects can be thrown around and possibly cause serious injury to vehicle occupants.
- Cover the Child Restraint when the vehicle is parked in sunlight. Parts of a Child Restraint can become very hot if left in the sun. Contact with these parts can burn a child's skin. Always check the surface of any metal or plastic parts before putting your child in the Child Restraint.
- To avoid strangulation, do not allow children to play with vehicle seat belts. If possible, move unused belts out of reach.
- Do not use anything to raise the Child Restraint off the vehicle seat such as a noodle or towel. In a sharp turn, sudden stop, or crash, the Child Restraint could slide and potentially cause serious injury.
- Never use a second-hand Child Restraint with an unknown history.
- Never use any accessories that are not included with this Child Restraint, unless specifically approved by Chicco. For more information, go to [www.chiccousa.com](http://www.chiccousa.com).

### Need Help Securing Your Child Restraint?

The following sources are available to help ensure your Child Restraint is properly installed:

- Contact Chicco USA by visiting our website at [www.chiccousa.com](http://www.chiccousa.com) or calling our Customer Service 1-877-424-4226. Please have Model and Serial Number available when you call. These are located on a label on the Base of the Child Restraint.
- Refer to your vehicle manual for Child Restraint installation tips.
- Contact a certified Child Passenger Safety Technician in your area by visiting [safercar.gov](http://safercar.gov) and select "Find Local Child Seat Help" or call 1-866-SEAT CHECK (1-866-732-8243).

## SEAT COMPONENTS

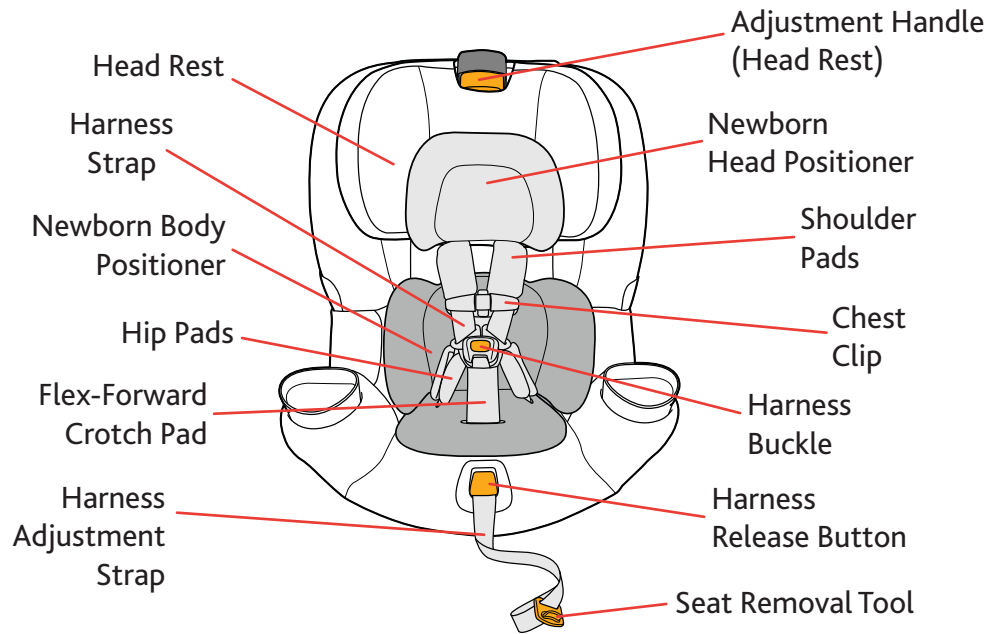

## SEAT COMPONENTS

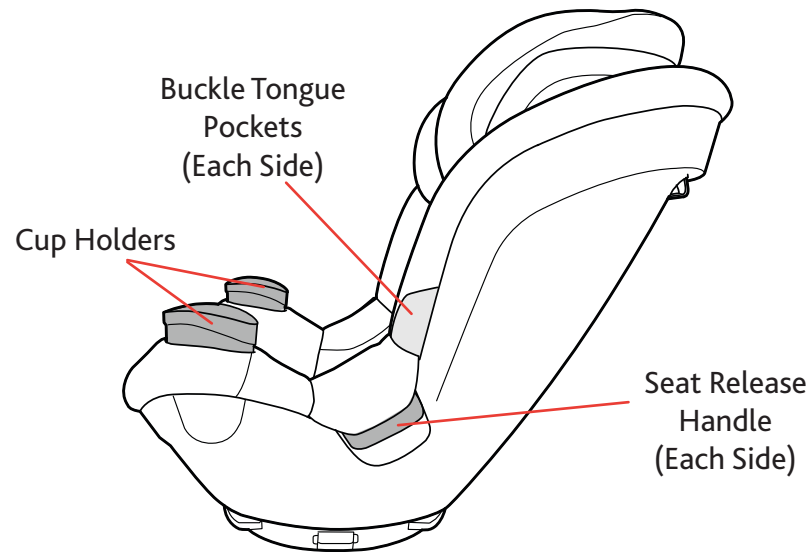

## BASE COMPONENTS

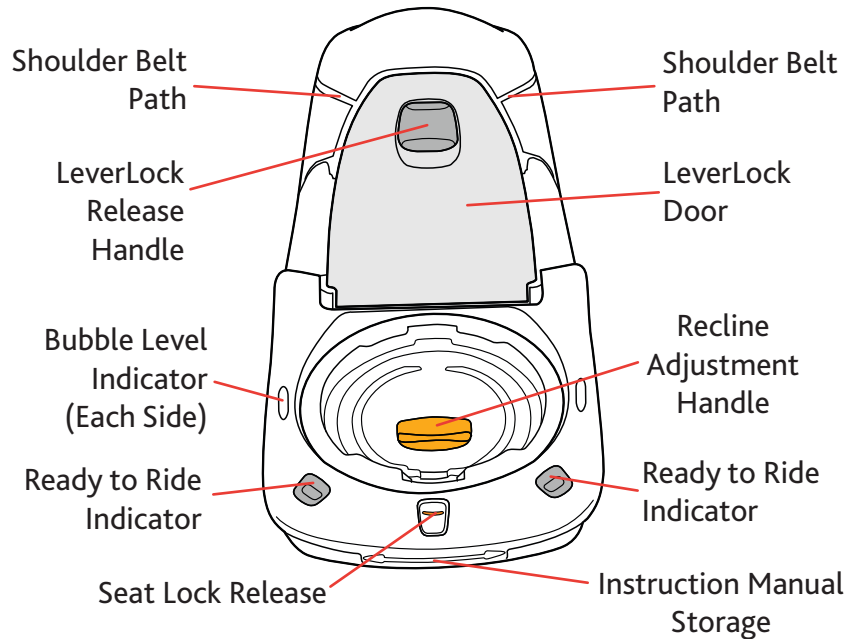

## BASE COMPONENTS

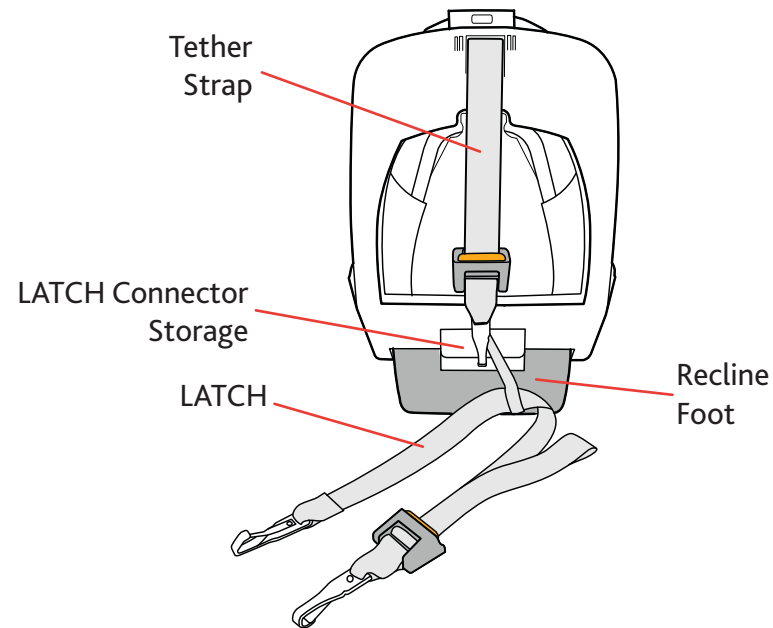

## LATCH AND TETHER COMPONENTS

**TETHER:**

- A** Tether Strap
- B** Tether Strap Adjuster
- C** Tether Hook

**LATCH:**

- D** LATCH Strap
- E** LATCH Strap Adjuster
- F** LATCH Hooks

## LATCH AND TETHER COMPONENTS

**Tether**  
**LATCH**

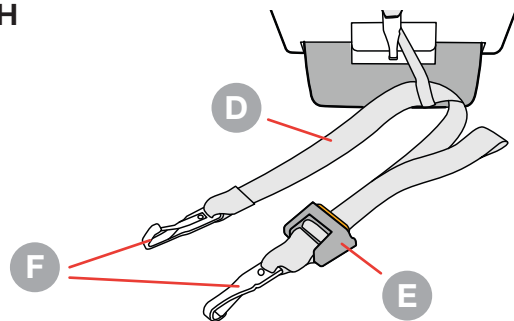
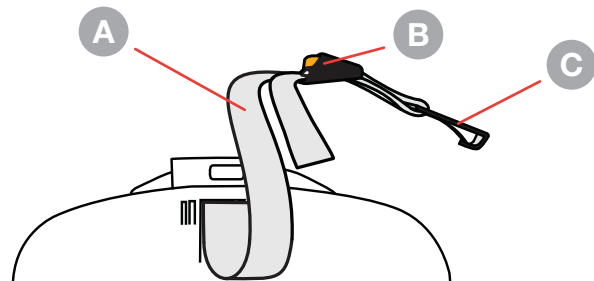

## LATCH AND TETHER STORAGE

⚠ Always make sure LATCH components are properly stored in the compartment when not in use.

**LATCH STORAGE:**

- 1 Store each LATCH strap in the compartment located on the back side of the Child Restraint Base when not in use (a).

**TETHER STORAGE:**

Store Tether on the back of Child Restraint Base when not in use. Attach Tether Hook to the bar and pull strap tight.

## LATCH AND TETHER STORAGE

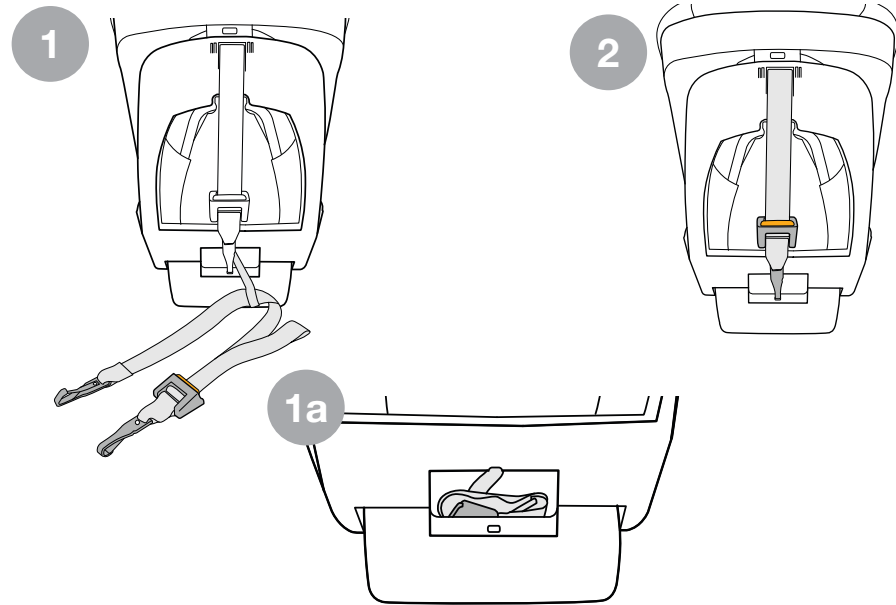

## SELECT REAR-FACING POSITION

**⚠ WARNING! REAR-FACING** use of this Child Restraint is ONLY for children who meet ALL of the requirements shown here. If the child is not within these requirements because the child is too large, review the FORWARD-FACING guidelines on page 26.

**⚠ NEVER** turn this Child Restraint FORWARD-FACING with an infant less than one year of age.

## SELECT REAR-FACING POSITION

**REAR-FACING:**

**With Newborn Head and Body Positioner:**

**4 – 11 lbs (1.8 – 5 kg)**

**Without Newborn Head and Body Positioner:**

**11 – 40 lbs (5 – 18 kg)**

Use **REAR-FACING** with children:

- Who weigh between 4 and 40 lbs (1.8 – 18 kg).
- Who are no taller than 43" (109 cm).
- When Harness Straps can be positioned at or below the child's shoulders\*.

See Harness Height Adjustment on page 92.

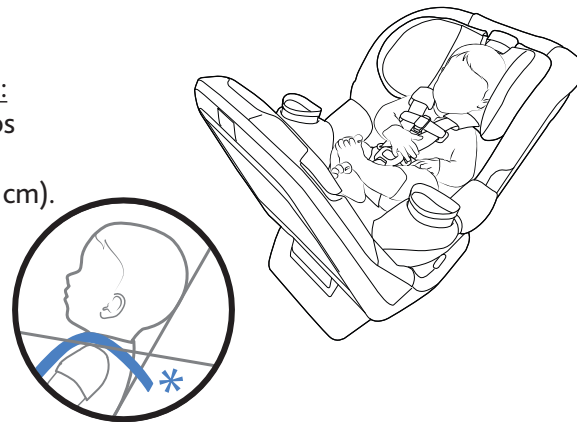
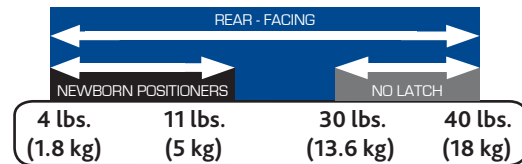

## SELECT FORWARD-FACING POSITION

**⚠ WARNING! FORWARD-FACING** use of this Child Restraint is **ONLY** for children who meet ALL of the requirements shown here. If the child is not within these requirements because they are too large, select a different child seat. If the child is not within these requirements because the child is too small, review the REAR-FACING guidelines on page 24.

**⚠ NEVER** turn this Child Restraint FORWARD-FACING with an infant less than one year of age.

## SELECT FORWARD-FACING POSITION

**FORWARD-FACING:**  
26.5 – 65 lbs (12 – 29.5 kg)

Use **FORWARD-FACING** with children:

- Who are at least one year old
- Who weigh between 26.5 and 65 lbs (12 – 29.5 kg).
- Who are 49" (125 cm) tall or less **OR** when the top of the ears are below the top of the Head Rest.
- When Harness Straps can be positioned at or above the child's shoulders\*.

See Harness Height Adjustment on page 92.

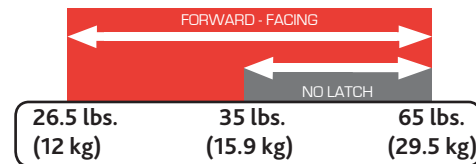

## REMOVING FLEX-FORWARD CROTCH PAD

- 1 Undo the Chest Clip and Buckle Tongues.

## REMOVING FLEX-FORWARD CROTCH PAD

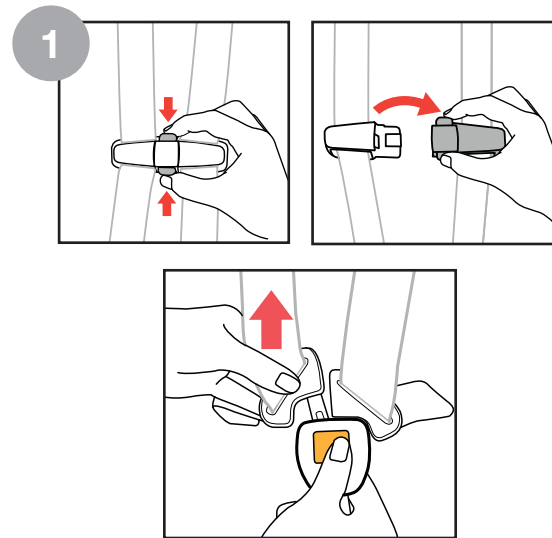



## REMOVING FLEX-FORWARD CROTCH PAD

- 2 Undo the snap button (a) and pull the strap out from behind the Harness Buckle (b).
- 3 Pull the Harness Buckle down, and at the same time pull up on the Flex-Forward Crotch Pad to remove.

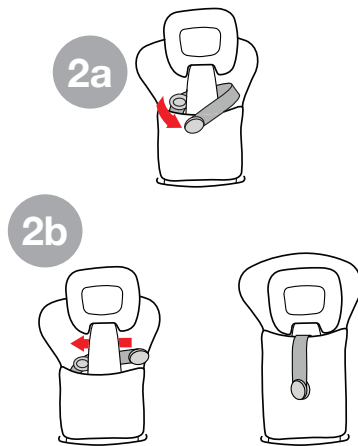

## REMOVING FLEX-FORWARD CROTCH PAD

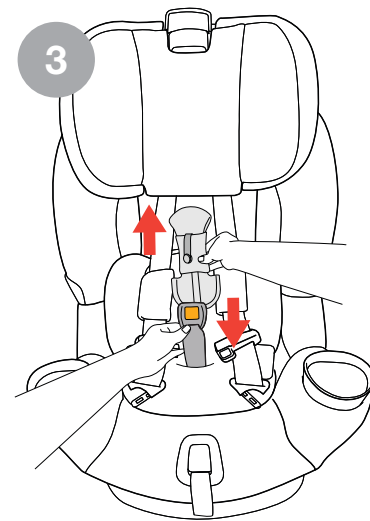

## ADJUSTING CROTCH STRAP

*Adjust Crotch Strap if strap is underneath child.  
When using Lap Belt Only installation (page 72), crotch strap must be in Position 1 at all times.*

- 1 Tuck the Buckle Tongues into the Buckle Tongue Pockets. Slide the lower section of the Backrest Padding down and remove it from the sleeve behind the top section of the Backrest Padding. Pull the crotch buckle through the seat pad.
- 2 Pull the lower section of Backrest Padding and the Seat Bottom Pad forward to locate the Crotch Strap Compartment below.

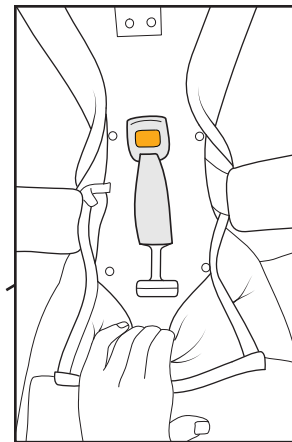
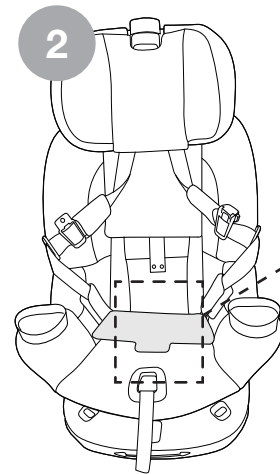
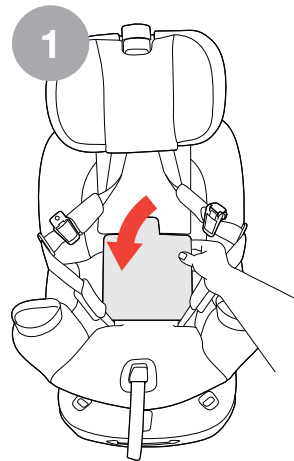

## ADJUSTING CROTCH STRAP

## ADJUSTING CROTCH STRAP

3

With the Crotch Strap in Position 1 (a), Guide the Crotch Strap forward through the Crotch Strap Compartment (b) and pull the Crotch Strap into Position 2 (c). Thread Crotch Strap through the correct Crotch Strap opening in the Seat Bottom Pad and reposition the Seat Bottom Pad. Reverse this Step to move the Crotch Strap back to Position 1.

## ADJUSTING CROTCH STRAP

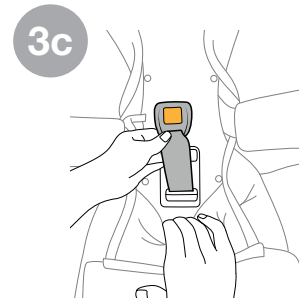
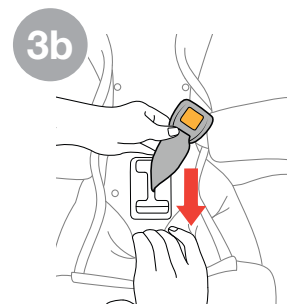
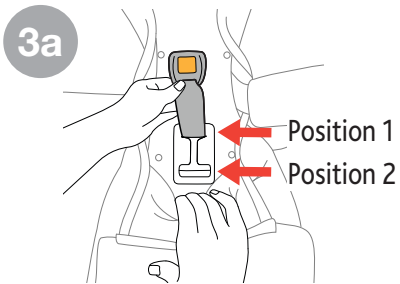

## NEWBORN HEAD AND BODY POSITIONER

**⚠ WARNING** - ONLY use the Newborn Head and Body Positioner if the child weighs between 4 and 11 lbs (1.8 and 5 kg).

**⚠ WARNING** - Both the Newborn Head and Body Positioners must be used at the same time.

To ensure a better fit for smaller infants the Newborn Head and Body Positioner may be needed. Do NOT use any other infant head rest, insert or pillows. Only use the one provided by Chicco for this Child Restraint.

- 1 Fold the ends of the Newborn Head Positioner in towards the center of the Head Positioner.
- 2 With both plastic inserts visible, locate one of the openings in the fabric on Child Restraint Head Rest. Slide the corresponding insert into the opening (a). Repeat for the other side (b).

## NEWBORN HEAD AND BODY POSITIONER

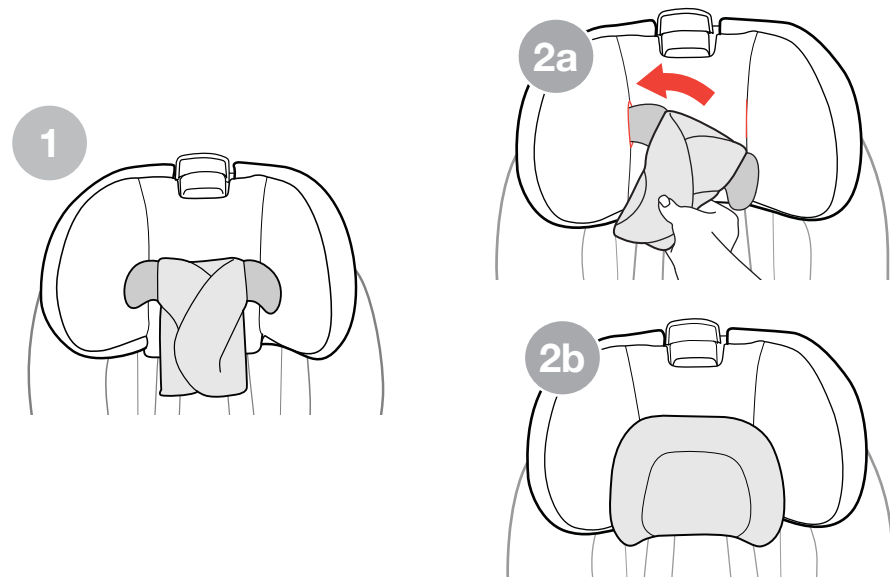

## NEWBORN HEAD AND BODY POSITIONER

- 3 Pull Harness Buckle through slot in the bottom of Newborn Body Positioner.
- 4 Pull both Harness Straps over the side panels of Newborn Body Positioner.
- 5 Push Newborn Body Positioner firmly into Child Restraint(a) to make sure it is properly positioned (b).

## NEWBORN HEAD AND BODY POSITIONER

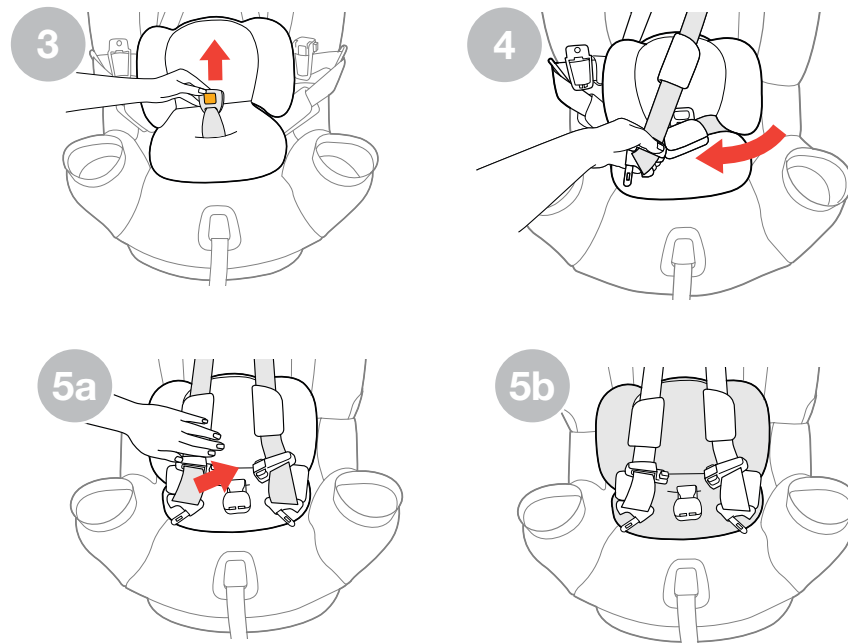

## INSTALL FLEX-FORWARD CROTCH PAD

- 1 To attach the Flex-Forward Crotch Pad, slide the Harness Buckle up through the Flex-Forward Crotch Pad.
- 2 Make sure to insert the bottom winged section of the Flex-Forward Crotch Pad down behind the Harness Buckle and into the Newborn Body Positioner opening.
- 3 Wrap the Crotch Pad strap through the opening in the Harness Buckle Strap. Fasten the snap button to secure the Flex-Forward Crotch Pad.

## INSTALL FLEX-FORWARD CROTCH PAD

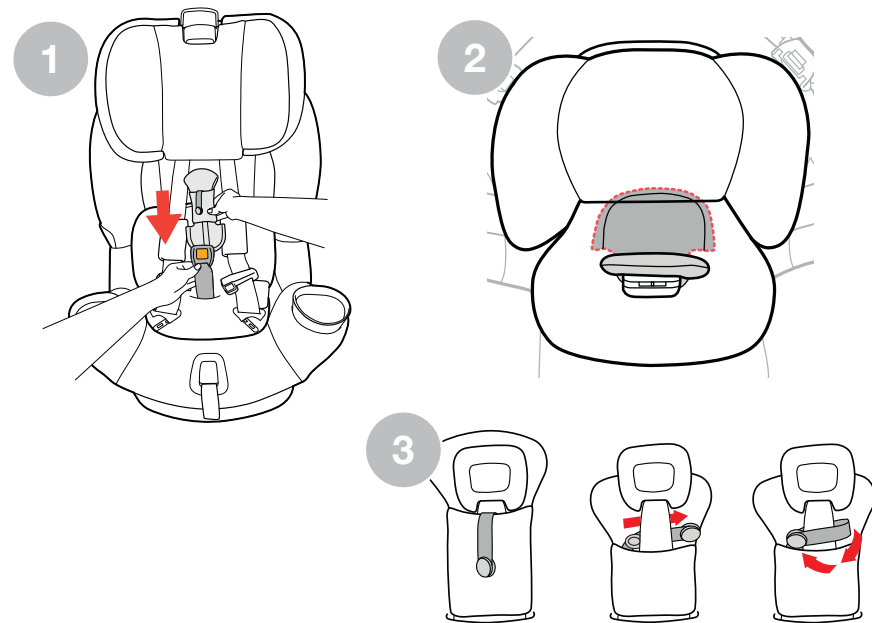

## VEHICLE SEATING POSITIONS



**⚠ WARNING! WHEN USING THIS CHILD RESTRAINT REAR-FACING, DO NOT PLACE THIS CHILD RESTRAINT IN A VEHICLE SEATING LOCATION WITH A FRONTAL AIR BAG, UNLESS THE AIR BAG CAN BE TURNED OFF.**

The back seat is the safest place for children 12 and under. See your vehicle owner's manual for Child Restraint installation and instructions.

## VEHICLE SEATING POSITIONS

Some vehicles have no seating positions which are compatible with this Child Restraint. If in doubt, contact the vehicle manufacturer for assistance. Only forward-facing vehicle seats can be used with this Child Restraint.

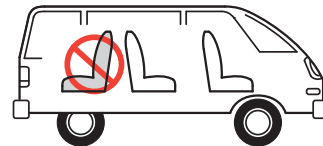

Make sure no more than 3 inches (76 mm) of the Child Restraint Base is past the edge of the vehicle seat in either Rear-Facing or Forward-Facing modes.

Do not use on a folded down vehicle seat back.

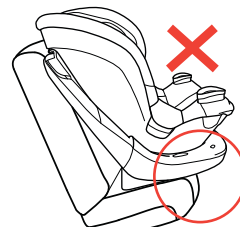

*The information in this section only applies to installation with vehicle seat belts.*

Vehicle seat belts differ from vehicle to vehicle. Refer to your vehicle owner's manual for specific information about seat belts and their use with Child Restraints.

**Shoulder belt with switchable retractor:**

Putting the shoulder belt in the locked/switched mode as the last step is optional. It is not necessary to put belt into locked/switched mode after the LeverLock Door is pushed closed.

**The following types of vehicle belts MUST NOT be used to install this Child Restraint.** If any of the belt types listed below are in the chosen seating position, choose another vehicle seating position or use LATCH if available.

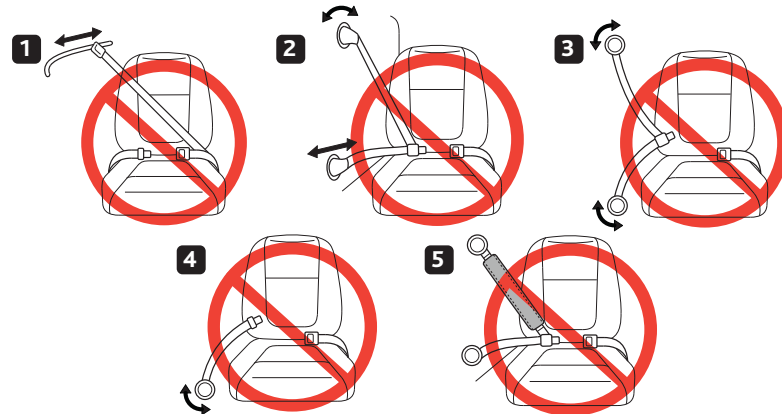

1. Motorized (automatic) vehicle belts.
2. Door mounted vehicle belts.
3. Lap-shoulder Belts with 2 retractors (unless Lap Belt has a "Lock Mode").
4. Non-Locking (ELR) Lap Belts.
5. Inflatable seat belts.



**⚠ WARNING:** This Child Restraint is designed to be used with lower LATCH anchors at the standard spacing (11 inches (28 cm)) **ONLY!** Refer to vehicle owner's manual for information about LATCH and Child Restraint installation positions.

### LATCH = Lower Anchors and Tethers for Children

United States Motor Vehicle Safety Standards have defined a system for installing Child Restraints in vehicles called LATCH. **LATCH may ONLY be used IN PLACE OF vehicle belt if the vehicle is equipped with LATCH anchor points. DO NOT use both the seat belt and LATCH at the same time. Please refer to the vehicle owner's manual for designated LATCH locations in vehicles.**

**LATCH** in the vehicle consists of a top tether anchor point and two lower anchor points. Some vehicles owner's manual use the term "**ISOFIX**". **LATCH** can also be used in vehicle seating positions equipped with **ISOFIX**.

If the vehicle is equipped with **LATCH**, the vehicle lower anchor points may be visible at the seat crease. If not visible, the seating position may be marked with a symbol (fig. a) or a colored dot. Check the vehicle owner's manual for vehicle top tether anchor locations. They may be identified using one of the anchor symbols (fig. b or fig. c).

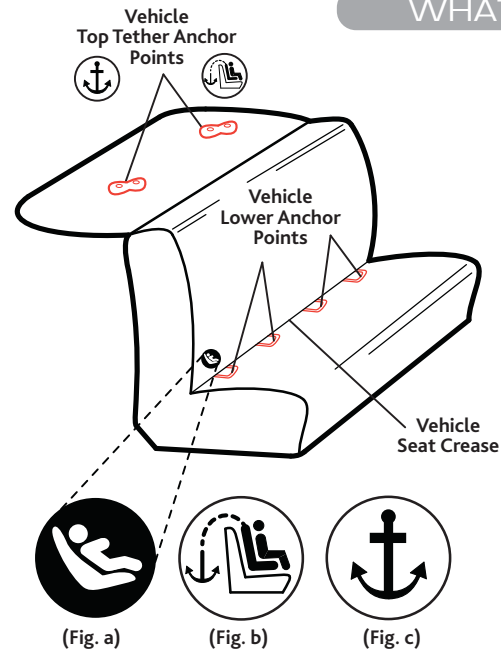

## WHAT IS A TETHER?



The tether is a strap on your Child Restraint that connects to a tether anchor in your vehicle. Tether anchor locations vary from vehicle to vehicle. Check your vehicle owner's manual and look for the tether anchor symbol as shown. A tether reduces movement of a Child Restraint in a crash and helps to achieve a tight installation.

**Vehicle tether anchors can be found in many different locations. Some of the typical locations are shown here. Refer to your vehicle owner's manual for exact locations, anchor identification, and requirements.**

## WHAT IS A TETHER?

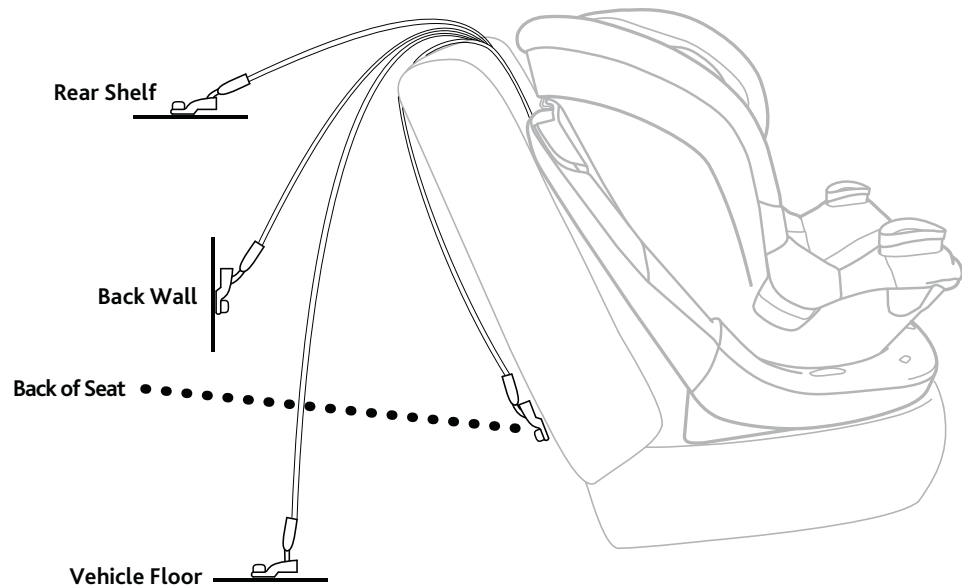

## BASE INSTALL

⚠ Infants may have difficulty breathing when in a sitting position. Make sure the seat is reclined properly so that your child's head does not fall forward. **Failure to properly recline the Child Restraint could increase the child's risk of serious injury or death.**

To install the Fit360 to the vehicle, the seat must be removed from the Base. The Base can be installed using Lap/Shoulder Belt Install, LATCH Install, or Lap Belt Install. Always use the Tether Strap for all 3 installation methods.

1  See page 42 for "Vehicle Seating Positions" before installing. Make sure the vehicle is on a level surface. The Seat must be removed from the Base to adjust the recline.

2 To remove the seat from the Base, first locate and squeeze a Seat Release Handle as shown. Turn seat towards mid-way point and allow seat to stop at the mid-way point stop.

3 Insert and press Seat Removal Tool into the Seat Lock Release opening on the Base, as shown. The Seat Lock Release will click when fully pressed.

4 Squeeze BOTH Seat Release Handles and lift up on the seat to remove from the Base. Set the Fit360 seat aside until Base is installed.

## BASE INSTALL

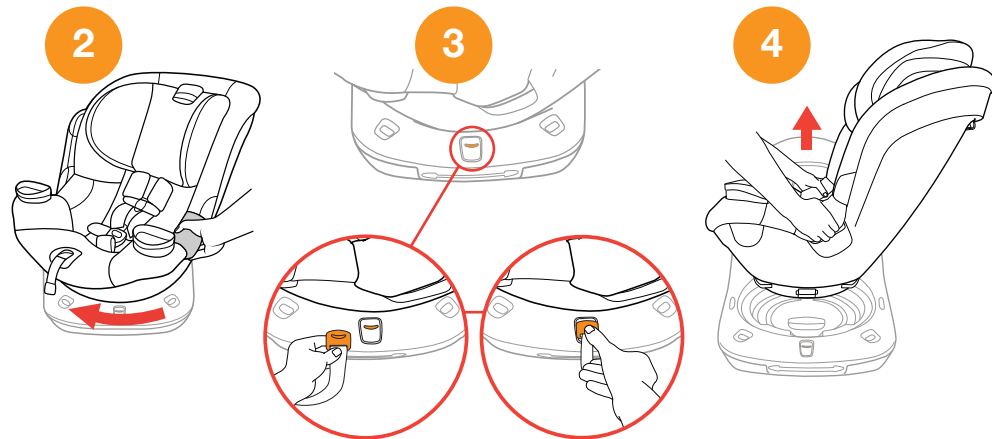

Note: Seat Removal Tool is on the end of the Harness Adjuster Strap.

## BASE INSTALL

- 5 Before placing the Base in the vehicle, remove Tether from the storage clip on the back of Base.
- 6 Place the Base on selected vehicle seat. Make sure it is not blocking the vehicle belt buckle. Lay Tether Strap over the back of the vehicle seat.

## BASE INSTALL

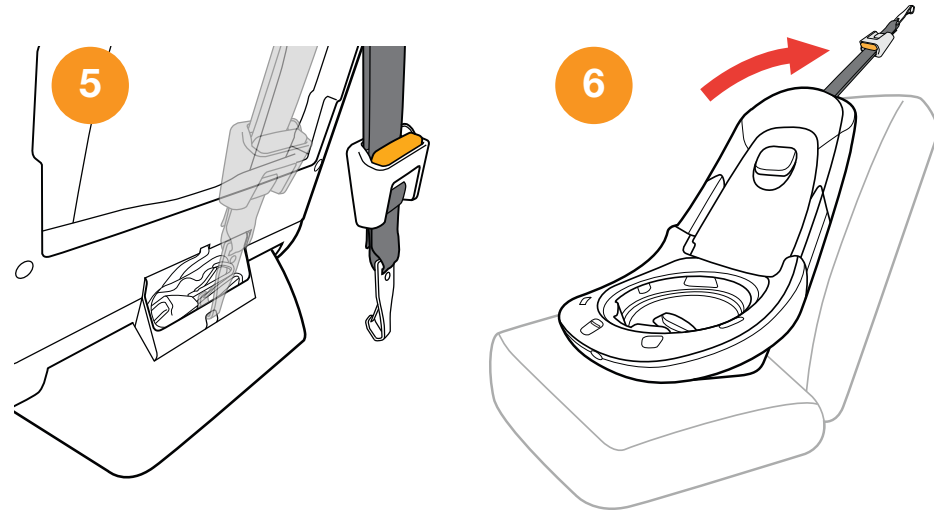

## BASE INSTALL

- 7 Locate the Recline Adjustment Handle, as shown. Lift up on the Recline Adjustment Handle to adjust the Base by sliding it forward or backward.

Locate the Bubble Level Indicator and adjust the Base recline to any position that the Bubble falls between the lines on the Bubble Level Indicator.

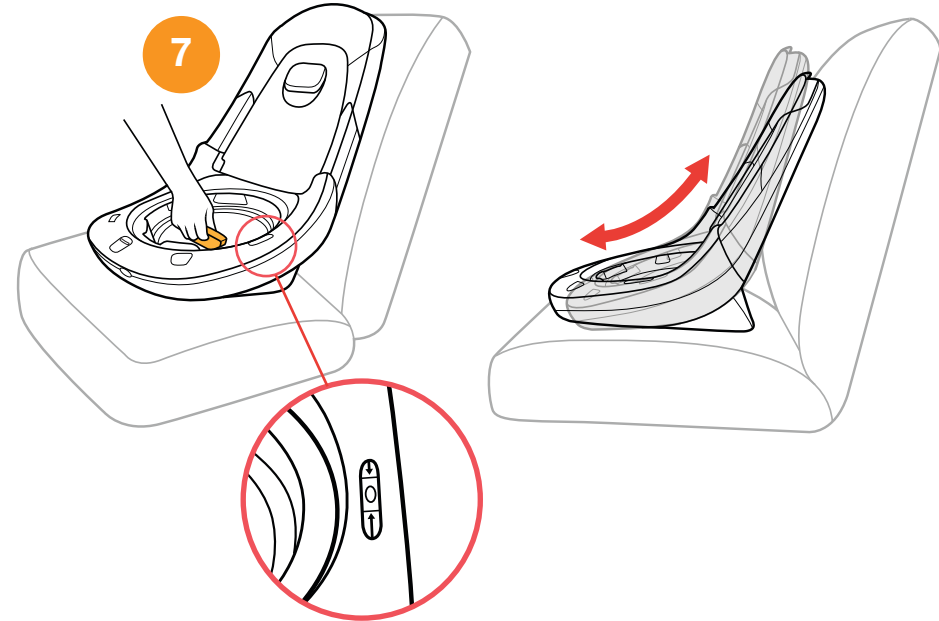

## BASE INSTALL

- 8 Check that the headrest of the vehicle seat does not interfere with the Headrest of the Child Restraint.

If the vehicle headrest pushes the Child Restraint forward, check your vehicle owner's manual to see if headrest removal is permitted. If so, follow the vehicle owner's manual to remove the headrest. If it is not permitted, raise the vehicle headrest or move the Child Restraint to a different vehicle seating location.

## BASE INSTALL

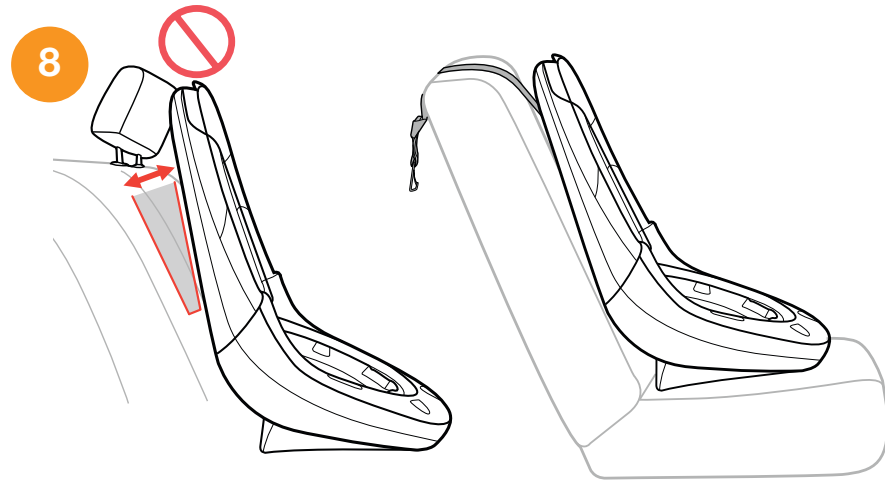

## INSTALL USING LAP-SHOULDER BELT

**Lap-Shoulder Belt with Tether Strap is the Recommended Installation Method**

- 1 With the Base adjusted to the correct recline, open the LeverLock Door.
- 2 Locate the LeverLock Release Handle in the middle of the LeverLock Door. At the top of the lever, push in with your thumb and lift up with your fingers.
- 3 Pull out the Vehicle Lap-Shoulder Belt. Then route the straps between the Base Frame and the LeverLock Door, as shown.
- 4 Buckle the Vehicle Lap-Shoulder Belt.

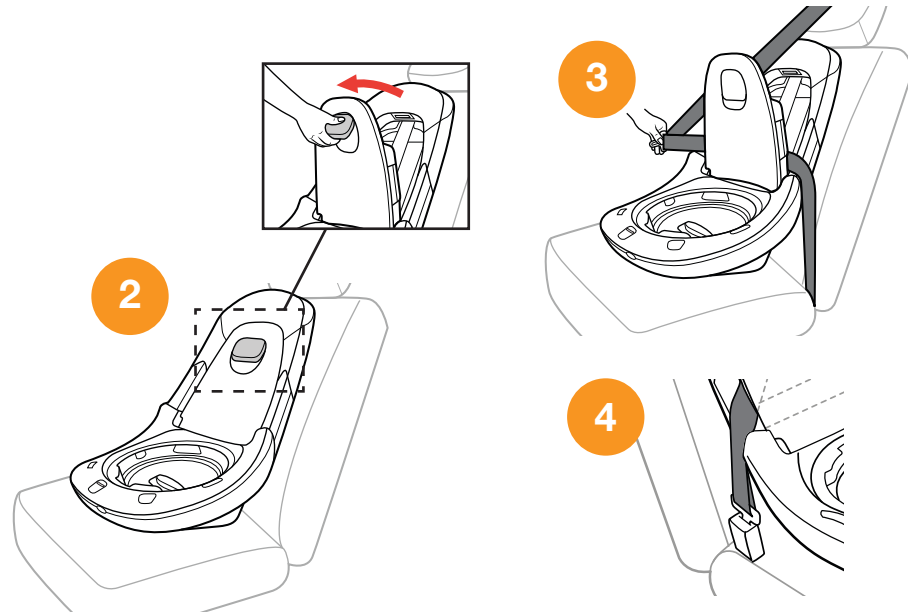

## INSTALL USING LAP-SHOULDER BELT

## INSTALL USING LAP-SHOULDER BELT

- 5 Pull any slack out of the lap and shoulder belt.
- 6 Make sure the Lap Belt lays flat over the Belt Path on both sides of the Base Frame (a). Then guide the Shoulder Belt across the back of the Base Frame and slide it into the Shoulder Belt Path on the opposite side of the vehicle buckle (b). Make sure the Lap Belt does not slip down in front of Belt Guide lip (c).

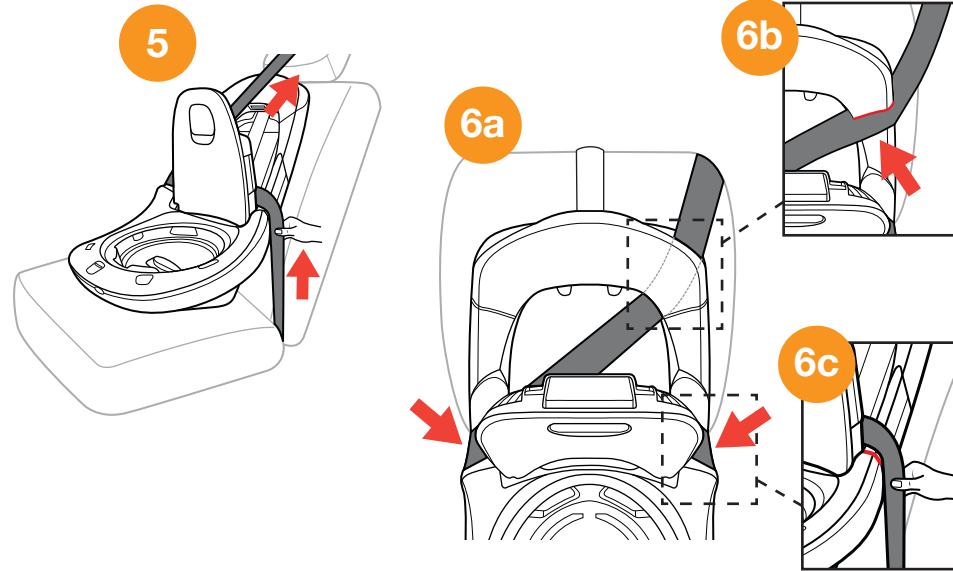



## INSTALL USING LAP-SHOULDER BELT

- 7 Push the LeverLock Door closed, making sure the door clicks into place.
- 8 Locate Tether Anchor in your vehicle (see pg. 48), and attach Tether Hook. Pull Tether Adjuster Strap to tighten. Always use the Tether Strap for installation.

## CHECK YOUR WORK

- ✓ Hold Base at each side near vehicle belt paths. Pull side to side and forward. Vehicle belt should remain tight and Base should not move more than 1" (25 mm) from vehicle seat back or side-to-side.
- ✓ Make sure Child Restraint is level for REAR-FACING or FORWARD-FACING use. Install for infants, make sure infant's head does not fall forward. If necessary, open LeverLock Door, undo the vehicle belt, re-adjust recline and repeat installation steps to make sure Child Restraint is installed properly.
- ✓ Check installation before every use!

## INSTALL USING LAP-SHOULDER BELT

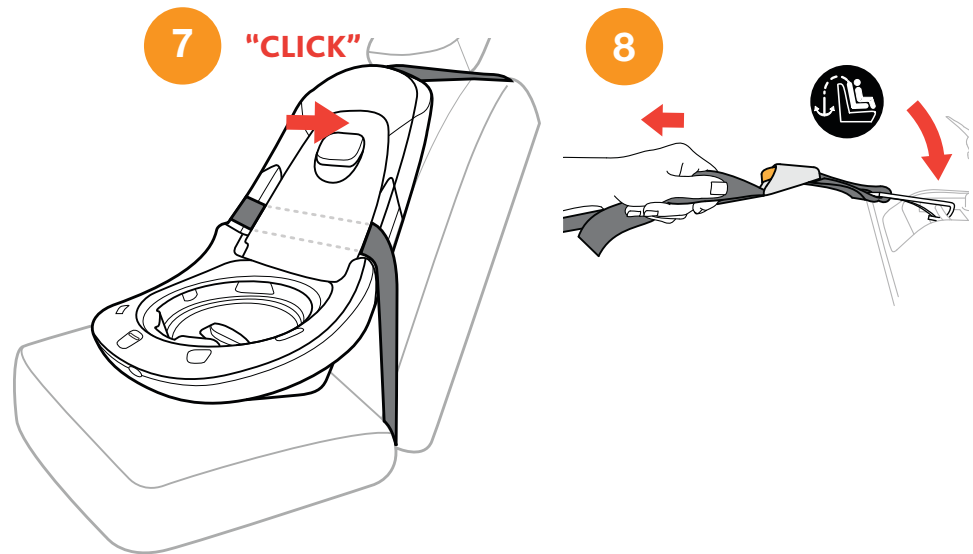

## INSTALL USING LATCH

## Lap-Shoulder Belt with Tether Strap is the Recommended Installation Method

⚠ Do not use the lower anchors of the child restraint anchorage system (LATCH system) to attach this Child Restraint when restraining a child weighing more than **30 lbs (13.6 kg)** for Rear-Facing and **35 lbs (15.9 kg)** for Forward-Facing.

⚠ When installing with LATCH in vehicle equipped with inflatable seat belts, the unused seat belt should NOT be buckled behind the Child Restraint System as this will engage the inflatable portion of the belt.

- 1 Remove the LATCH straps from the LATCH Storage compartment (see pg. 23). Make sure LATCH Adjuster strap is loosened to its full length.
- 2 With the Base adjusted to the correct recline, open the LeverLock Door. Locate the lever in the middle of the LeverLock Door. At the top of the lever, push in with your thumb and lift up with your fingers.

## INSTALL USING LATCH

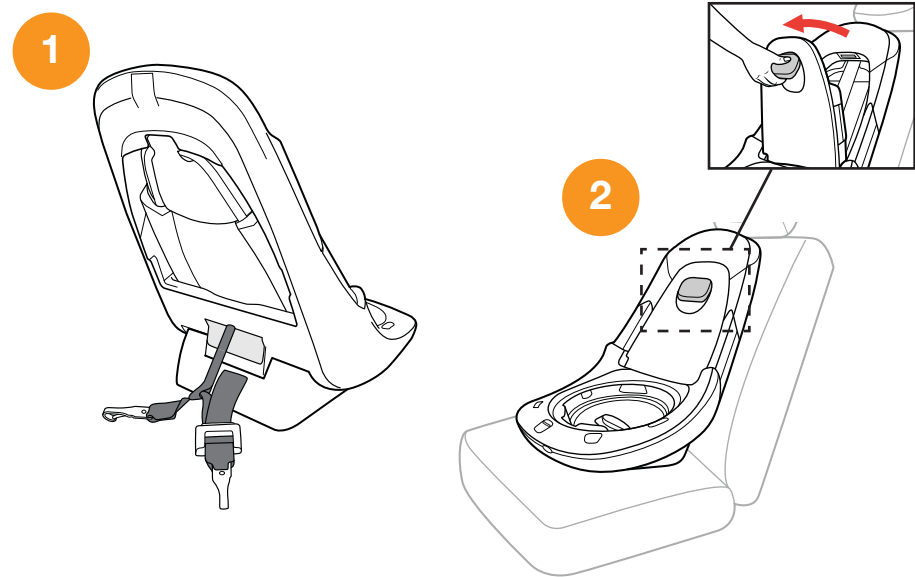

## INSTALL USING LATCH

- 3 Pull LATCH straps through the Base Frame opening (a). Then route the straps between the Base Frame and the LeverLock Door, as shown (b).

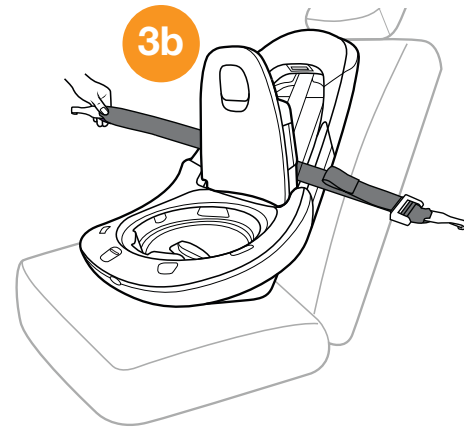
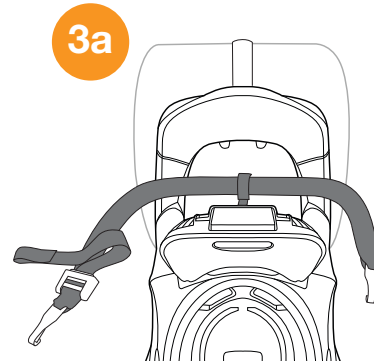

## INSTALL USING LATCH

- 4 Locate the LATCH anchor bars in your vehicle. Attach both LATCH Connectors to the vehicle LATCH anchor bars.
- 5 Pull up on the end of the LATCH Adjuster strap until strap is tight. Make sure to remove all of the slack in the LATCH straps.

## INSTALL USING LATCH

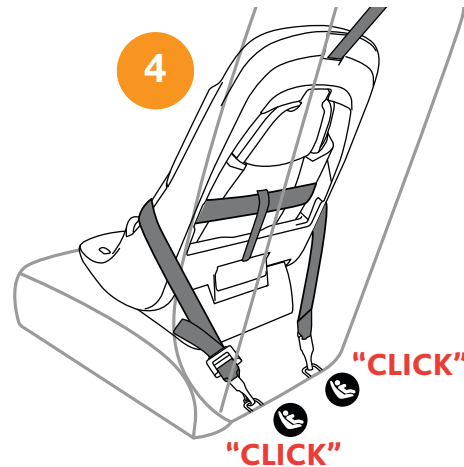

⚠ Do not install by this method for a child weighing more than **30 lbs (13.6 kg)** for Rear-Facing and **35 lbs (15.9 kg)** for Forward-Facing.

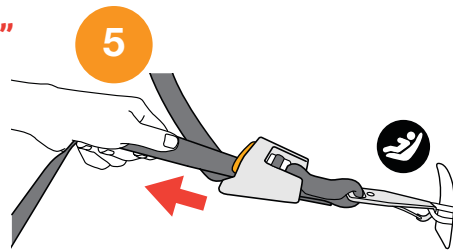

## INSTALL USING LATCH

- 6 Make sure the LATCH strap lays flat over the belt guides on both sides of the Base Frame.
- 7 Push the LeverLock Door closed, making sure the door clicks into place.
- 8 Locate Tether Anchor in your vehicle (see pg. 48), and attach Tether Hook. Pull Tether Adjuster Strap to tighten. Always use the Tether Strap for installation.

## CHECK YOUR WORK

- ✓ Hold Base at each side near vehicle belt paths. Pull side to side and forward. Base should not move more than 1" (25 mm) from vehicle seat back or side-to-side.
- ✓ Make sure Child Restraint is level for REAR-FACING or FORWARD-FACING use. Install for infants, make sure infant's head does not fall forward. If necessary, open LeverLock Door, loosen LATCH strap, re-adjust recline and repeat installation steps to make sure Child Restraint is installed properly.
- ✓ Check installation before every use!



## INSTALL USING LATCH

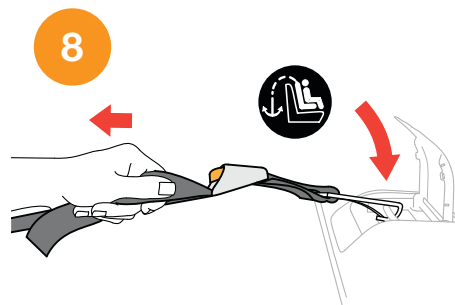

## INSTALL USING LAP BELT ONLY

## Lap-Shoulder Belt with Tether Strap is the Recommended Installation Method

- 1 With the Base adjusted to the correct recline (see page 54), open the LeverLock Door.

When installing with Lap Belt Only and Tether Strap for Forward-Facing, adjust the Base to Recline 2 ONLY (a).

When installing with Lap Belt Only without Tether Strap for Forward-Facing, adjust the Base to Recline 6 ONLY. It is OK if the bubble is outside of the level lines for this installation (b).

- 2 Locate the lever in the middle of the LeverLock Door. At the top of the lever, push in with your thumb and lift up with your fingers.

## INSTALL USING LAP BELT ONLY

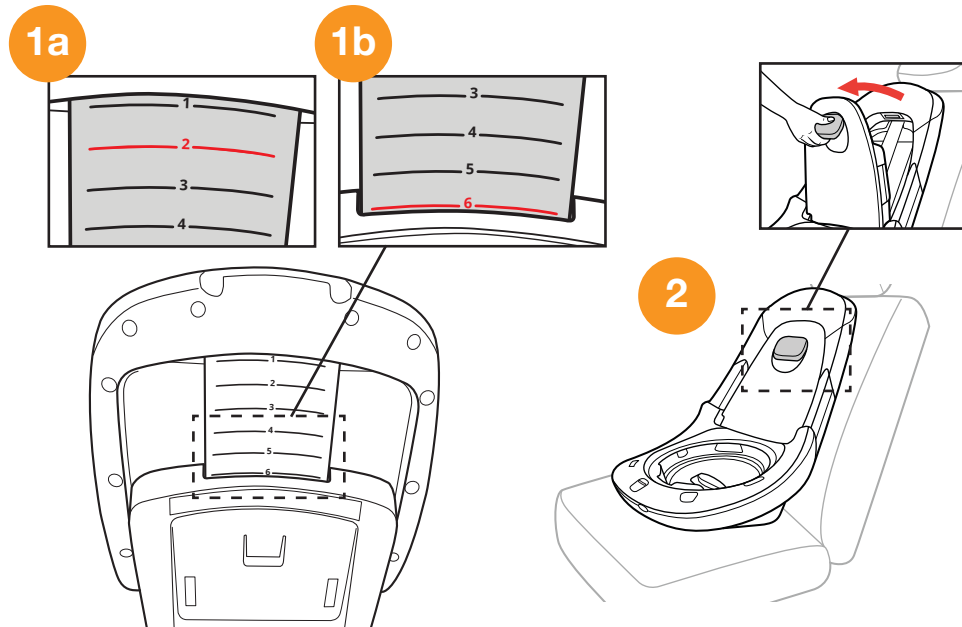

## INSTALL USING LAP BELT ONLY

- 3 Pull out the Vehicle Lap Belt. Then route the strap between the Base Frame and the LeverLock Door, as shown.
- 4 Buckle the Vehicle Lap Belt.
- 5 Remove any slack from the lap belt.
- 6 Make sure the Lap Belt lays flat over the belt guides on both sides of the Base Frame.

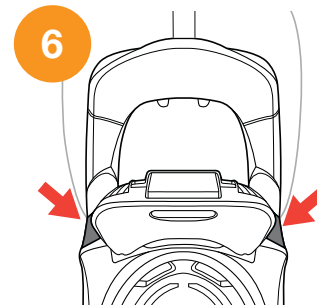
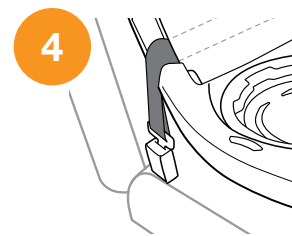

## INSTALL USING LAP BELT ONLY

## INSTALL USING LAP BELT ONLY

- 7 Push the LeverLock Door closed, making sure the door clicks into place.
- 8 Locate the Tether Anchor in your vehicle (see pg. 48), and attach Tether Hook. Pull Tether Adjuster Strap to tighten. Always use the Tether Strap for installation.

## CHECK YOUR WORK

- ✓ Hold Base at each side near vehicle belt paths. Pull side to side and forward. Vehicle belt should remain tight and Base should not move more than 1" (25 mm) from vehicle seat back or side-to-side.
- ✓ Make sure Child Restraint is level for REAR-FACING or FORWARD-FACING use. Install for Infants, make sure infant's head does not fall forward. If necessary, open LeverLock Door, undo the vehicle belt, re-adjust recline and repeat installation steps to make sure Child Restraint is installed properly.
- ✓ Check installation before every use!

## INSTALL USING LAP BELT ONLY

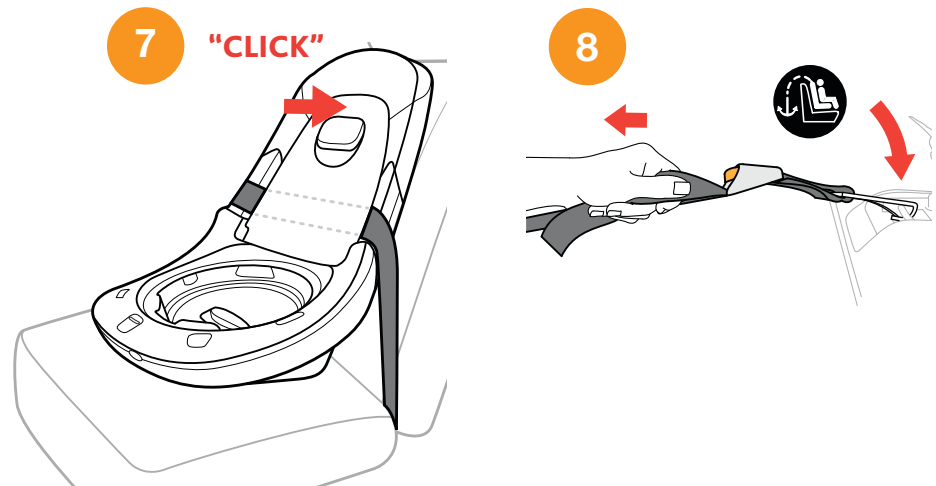



## REAR-FACING SETUP

**⚠ WARNING** - The seat cannot be used without being attached to the base.

**⚠** Infants may have difficulty breathing when in a sitting position. Make sure the seat is reclined properly so that your child's head does not fall forward. **Failure to properly recline the Child Restraint could increase the child's risk of serious injury or death.**

- 1 Make sure the Base is installed securely.
- 2 Holding the Seat at a 90 degree angle to the base, line up the Seat Bottom to the Base. Insert the Seat into the Base until it clicks into position.

## REAR-FACING SETUP



## REAR-FACING SETUP

- 3** Rotate the seat to the Rear-Facing position (a). Make sure the Ready to Ride Indicator is GREEN and not RED (b). If the Ready to Ride Indicator is RED, rotate the Seat without depressing the Release Handles to lock it into position.

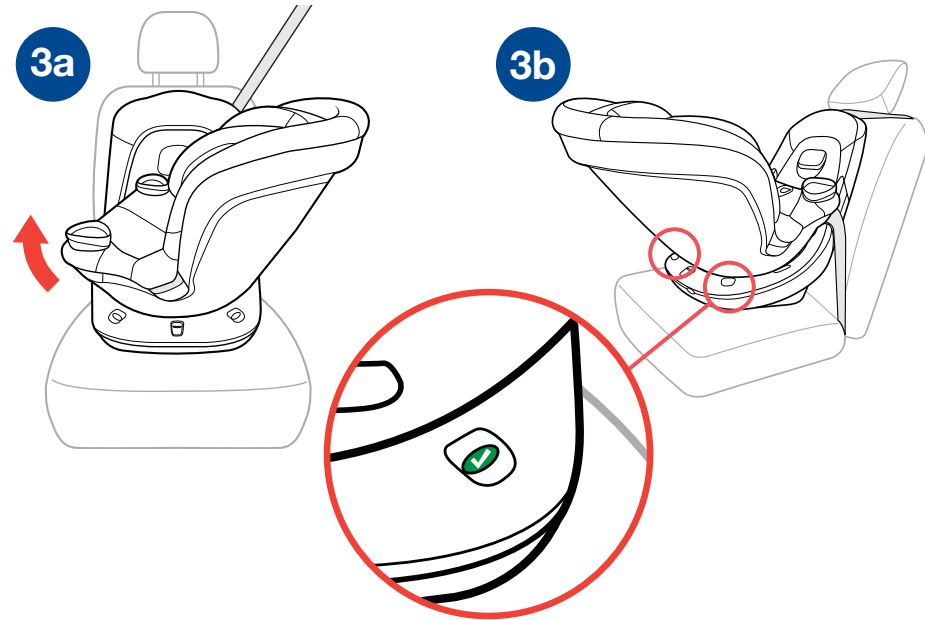

## FORWARD-FACING SETUP

**⚠ WARNING** - The seat cannot be used without being attached to the base.

- 1 Make sure the Base is installed securely.
- 2 Holding the Seat at a 90 degree angle, line up the Seat Bottom to the Base. Insert the Seat into the Base until it clicks into position.

## FORWARD-FACING SETUP



## FORWARD-FACING SETUP

- 3** Rotate the seat to the Forward-Facing position (a). Make sure the Ready to Ride Indicator is GREEN and not RED (b). If the Ready to Ride Indicator is RED, rotate the Seat without depressing the Release Handles to lock it into position.

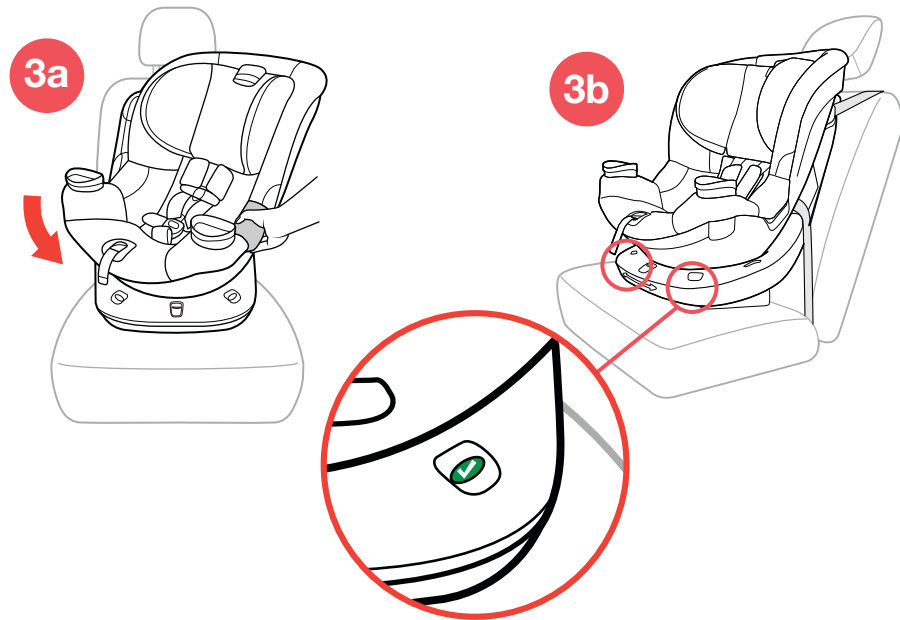

## SECURING CHILD WITH HARNESS

For a better fit in the Child Restraint with smaller infants, the Newborn Head and Body Positioner provided may be needed. See page 36 for more details.

If Crotch Strap is under child, the crotch strap will need to be re-positioned, refer to page 32 "Adjusting Crotch Strap".

- 1 Rotate the Seat to face the vehicle door, then loosen Harness by pressing Harness Release Button on the front of the Child Restraint and pulling forward on both of the Harness Straps.
- 2 Unbuckle Harness by pressing the button on the Harness Buckle and pulling out both Buckle Tongues.
- 3 Open Chest Clip by pressing the top and bottom buttons and pulling in an upward direction. Both sections of the Chest Clip will come apart.

## SECURING CHILD WITH HARNESS

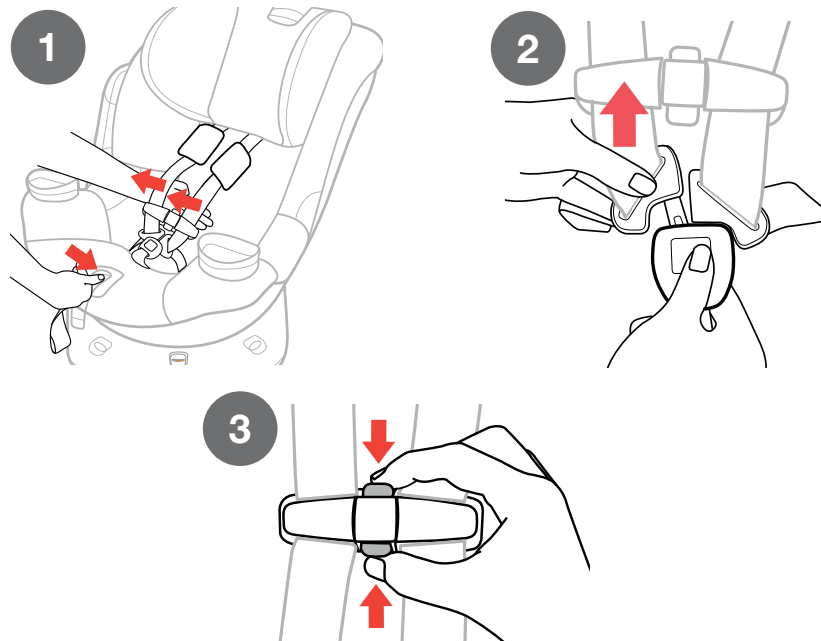

## SECURING CHILD WITH HARNESS

- 4 To hold the straps out of the way, locate the Buckle Tongue Pockets on both sides of the Child Restraint. Slide each Buckle Tongue into the coordinating side pocket, as shown.

*Note: If Base is installed with Lap Belt Only (page 72) in Forward-Facing mode, see special instruction on page 100.*

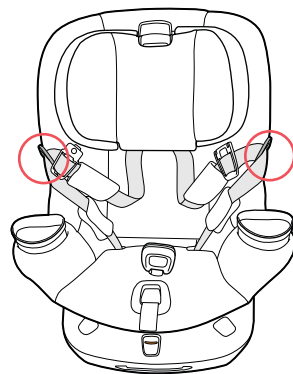
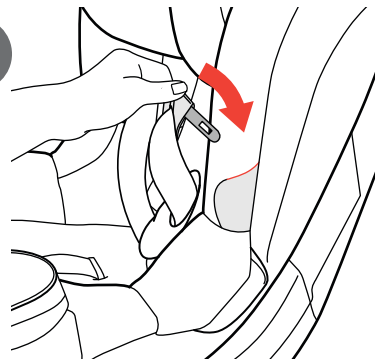

## SECURING CHILD WITH HARNESS

## SECURING CHILD WITH HARNESS

- 5 Place child in Child Restraint with child's back flat against the back of the seat. Pull Harness Straps over the child's shoulders and around the child's waist. Make sure there are no twists in Harness Strap.

*Clothing, such as bulky winter coats that interfere with the proper placement or adjustment of the Harness system should never be used. Make sure the Harness Straps lie flat on the child's shoulders, are adjusted snugly so that clothing is compressed and the child cannot lean forward, and the Chest Clip is at arm level.*

## SECURING CHILD WITH HARNESS

5

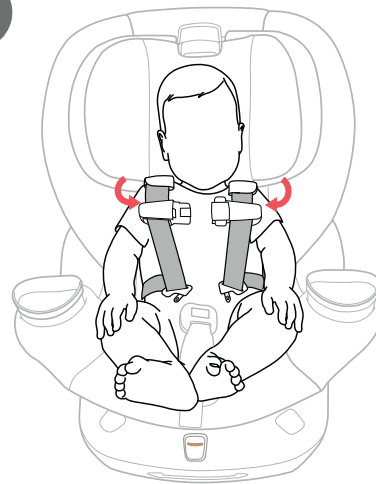

## SECURING CHILD WITH HARNESS

- 6 Adjust Harness Strap height position up or down by squeezing Adjustment Handle on top of Head Rest. Harness must be loose to avoid interfering with Head Rest height adjustment. Make sure Head Rest locks into position before tightening Harness.

**REAR-FACING POSITION** - Position the Harness Straps at or below the child's shoulders.

**FORWARD-FACING POSITION** - Position the Harness Straps at or above the child's shoulders.

## SECURING CHILD WITH HARNESS

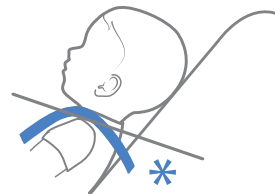
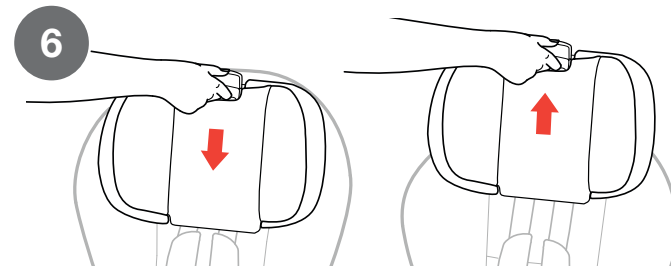

**REAR-FACING**

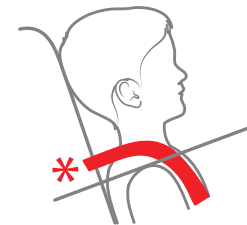

**FORWARD-FACING**



## SECURING CHILD WITH HARNESS

- 7 Insert each Buckle Tongue into Harness Buckle; listen for a click (a). Pull up firmly on both Buckle Tongues to make sure that they are securely latched (b).

## SECURING CHILD WITH HARNESS

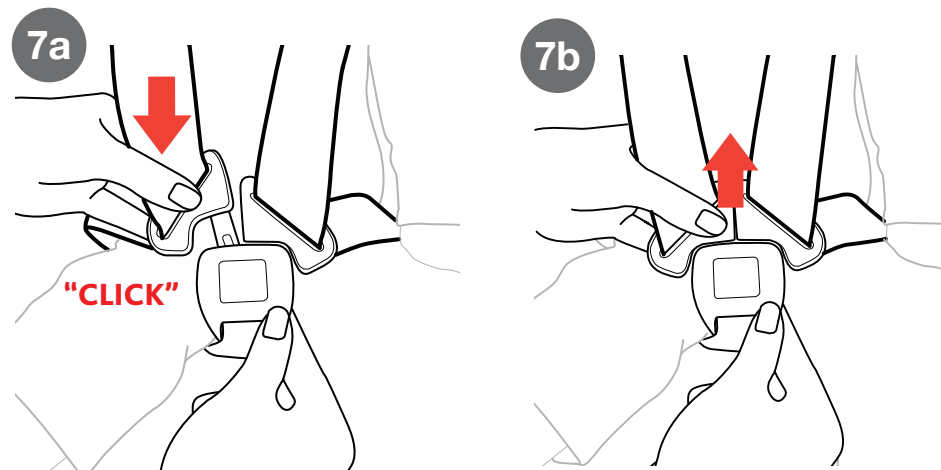

## SECURING CHILD WITH HARNESS

- 8 Fasten Chest Clip by moving the button half of the clip over top of the post side and bring them together; listen for a click.

*Harness straps must fit snugly and lay flat on the center of your child's shoulders.*

- 9 Push Chest Clip and Shoulder Pads down away from the child's neck and towards the Harness Buckle. Pull on both shoulder straps to remove all slack from below.

## SECURING CHILD WITH HARNESS

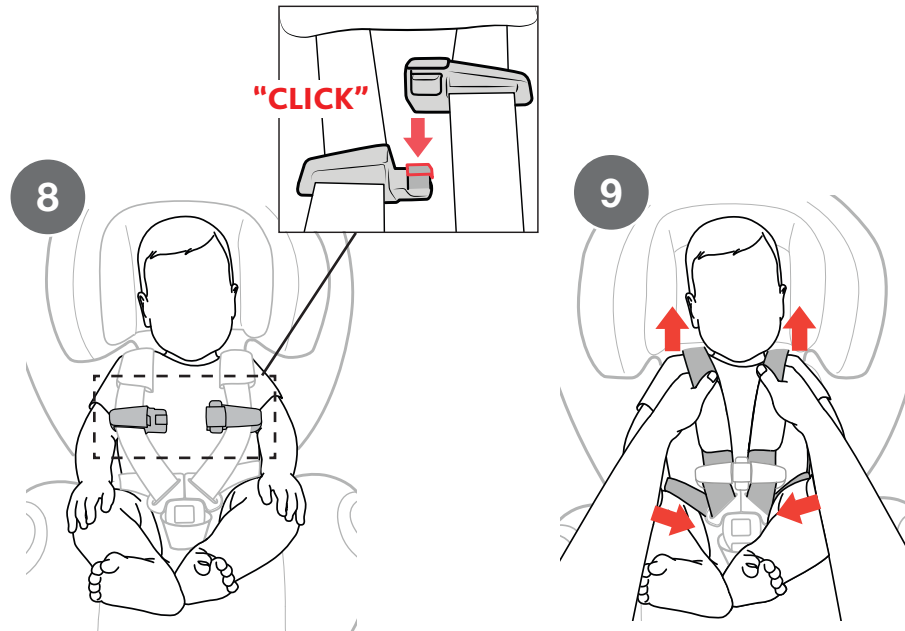

## SECURING CHILD WITH HARNESS

- 10** Tighten the harness by pulling slowly on Harness Adjustment Strap until the harness is snug on child (a). If you can pinch a fold in the strap at the child's shoulders, the harness is too loose (b). If the harness is too loose pull the Harness Adjuster strap more.
- 11** Move the Shoulder Pads up to the child's shoulders. Slide Chest Clip up to center of child's chest, level with the armpits.

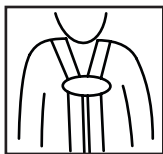

**⚠ WARNING** - If harness is not snug around your child, child could be ejected in a sudden stop or crash resulting in serious injury or death.

## SECURING CHILD WITH HARNESS

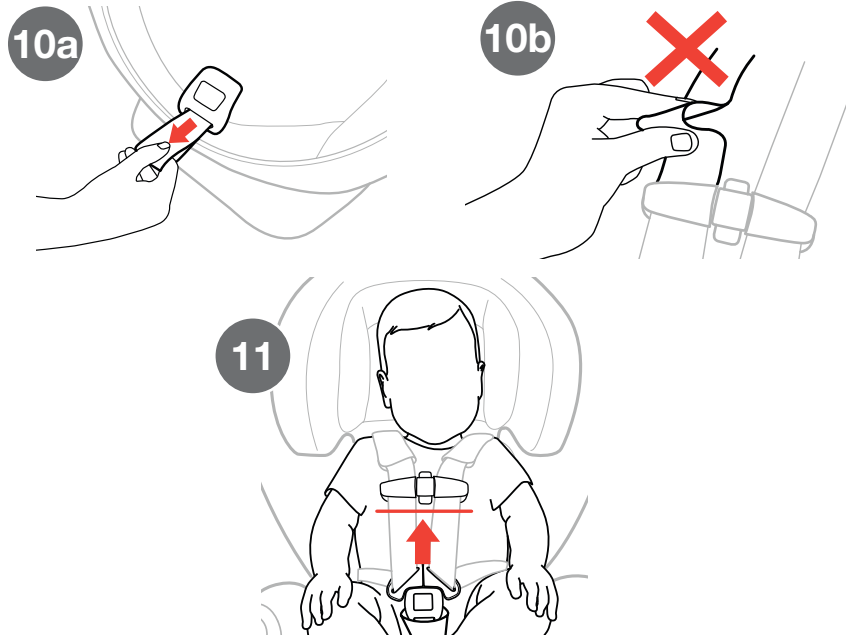

## SECURING CHILD CHECKLIST

- ✓ **Harness Straps must be snug.** If you can pinch a fold in the strap at the shoulders, the harness is too loose. A snug strap should not allow any slack. It lies in a relatively straight line without sagging. It does not press on the child's flesh or push the child's body into an unnatural position.

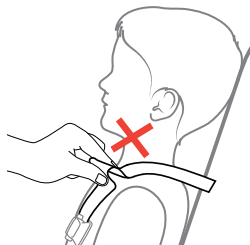

- ✓ To ensure a better fit for smaller infants, the Newborn Head and Body Positioner may be needed. Never place extra padding under or behind the child. Only use the Newborn Head and Body Positioner.
- ✓ Straps must lay flat, free of twists and centered on top of the child's shoulders.
- ✓ Check the height of the Harness Straps: Position the Harness Straps at or below the child's shoulders for REAR-FACING and at or above the child's shoulders for FORWARD-FACING.



REAR-FACING

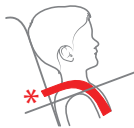

FORWARD-FACING

## SECURING CHILD CHECKLIST

- ✓ Check the position of Chest Clip: Chest Clip should be centered on the child's chest, level with the armpits.
- ✓ Never secure child in Child Restraint with child dressed in bulky garments or heavy clothing. Heavy clothing can prevent harness from being properly tightened around child.
- ✓ Never secure child in Child Restraint with child wrapped in a blanket. To keep child warm, place a blanket over child AFTER you have properly secured and tightened harness around child.

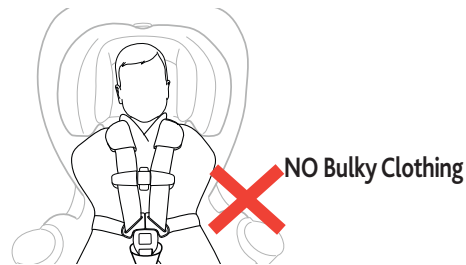

**⚠ WARNING** - If harness is not snug around your child, child could be ejected in a sudden stop or crash resulting in serious injury or death.

## INSTALLATION ON AN AIRCRAFT

*When traveling by airplane with your child, Chicco recommends taking the Child Restraint on the airplane with you so that you can use it with your child. Not only will it protect your child during take-off, landing, and turbulence, it will also allow your child to be more comfortable.*

- This Child Restraint is certified for use on aircraft. Contact the airline prior to travel to discuss their Child Restraint policy.
- Use this Child Restraint only on FORWARD-FACING aircraft seats.

- 1** Lift the aircraft seat armrest up and place Fit360 on the seat.
- 2** Rotate 90 degrees

## INSTALLATION ON AN AIRCRAFT

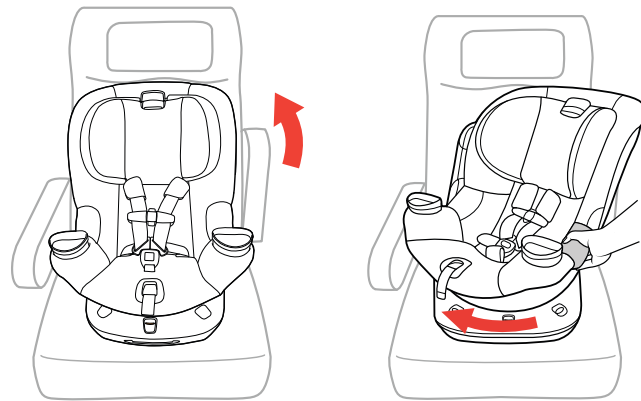

## INSTALLATION ON AN AIRCRAFT

- 3 Place lap belt over top of the Lever Lock Door and over the belt guides.
- 4 Buckle the belt and remove all slack making sure the belt lays flat over the belt guides on both sides. Then rotate the Fit360 Seat into the Rear-Facing or Forward-Facing position. Make sure the Ready to Ride Indicator is GREEN and not RED. If the Ready to Ride Indicator is RED, rotate the Seat without depressing the Release Handles to lock it into position.

## CHECK YOUR WORK

- ✓ Hold Base at each side near belt paths. Pull side to side and forward. Aircraft belt should remain tight and Base should not move more than 1" (25 mm) from aircraft seat back or side-to-side.
- ✓ Make sure Child Restraint is level for REAR-FACING or FORWARD-FACING use. Install for Infants, make sure infant's head does not fall forward. If necessary, undo the aircraft belt, re-adjust recline and repeat installation steps to make sure Child Restraint is installed properly.
- ✓ Check installation before every use!

## INSTALLATION ON AN AIRCRAFT

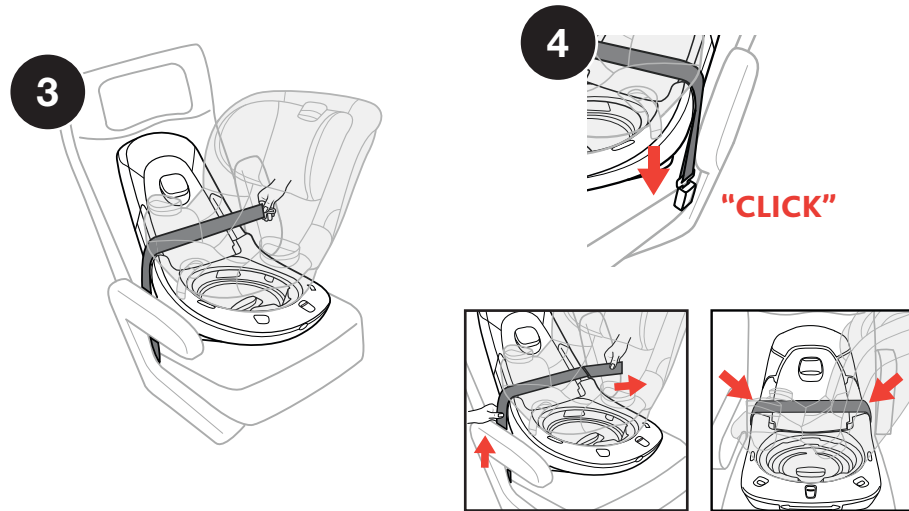

## CUP HOLDER

**⚠ WARNING** - Do NOT use Cup Holder to hold hot liquids. PLASTIC CONTAINERS ONLY - No glass or metal containers. Only use cups with less than 12 oz. (355 ml) capacity. Never place sharp or pointed objects in Cup Holder. In a crash these objects could hit you or your child and cause serious injuries.

- 1 Rotate the Cup Holders outward in opposite directions to unlock. Pull up on both Cup Holders to remove. To re-attach, line up the key on the bottom of the each Cup Holder and insert into the pocket. The arrow inside the Cup Holder will be toward the outside of the seat. Rotate the Cup Holders 1/4 turn so that the arrows are toward the front of the seat.

## CUP HOLDER

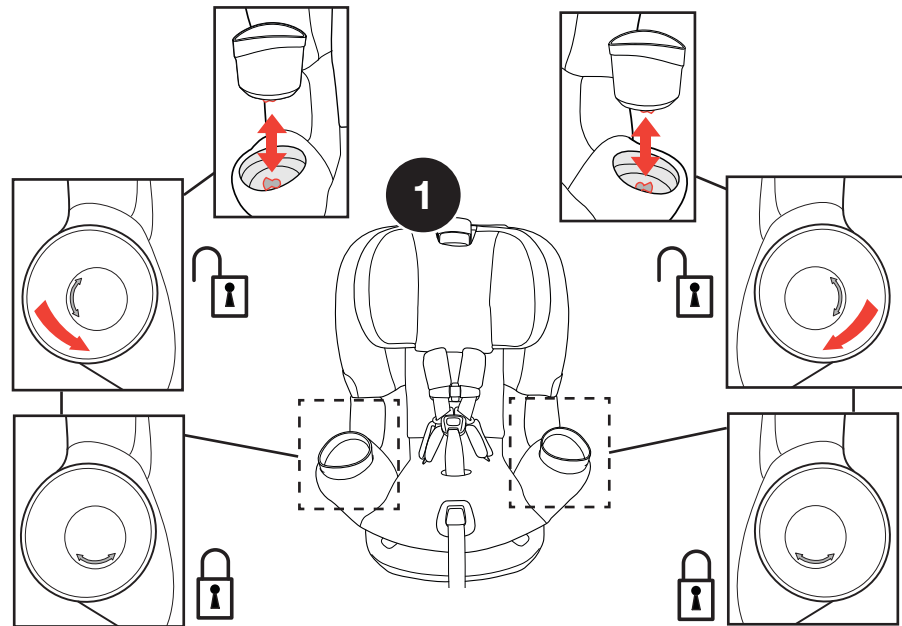

## CLEANING AND MAINTENANCE

### 1 REMOVING SHOULDER PADS:

Unhook the Velcro and remove Shoulder Pads as shown.

### 2 INSTALL SHOULDER PADS:

Re-attach Shoulder Pads by folding the hook and loop Tab over the Harness Strap (a). Secure both hook and loop Tabs together (b). Make sure they are oriented as shown (c).

### 3 REMOVING NEWBORN BODY POSITIONER COVER:

Unzip the side zipper (a) and remove the molded foam insert (b).

### 4 RE-INSTALL NEWBORN BODY POSITIONER MOLDED FOAM:

Insert the molded foam into the side of the Newborn Body Positioner Cover. Zip up the zipper.

## CLEANING AND MAINTENANCE

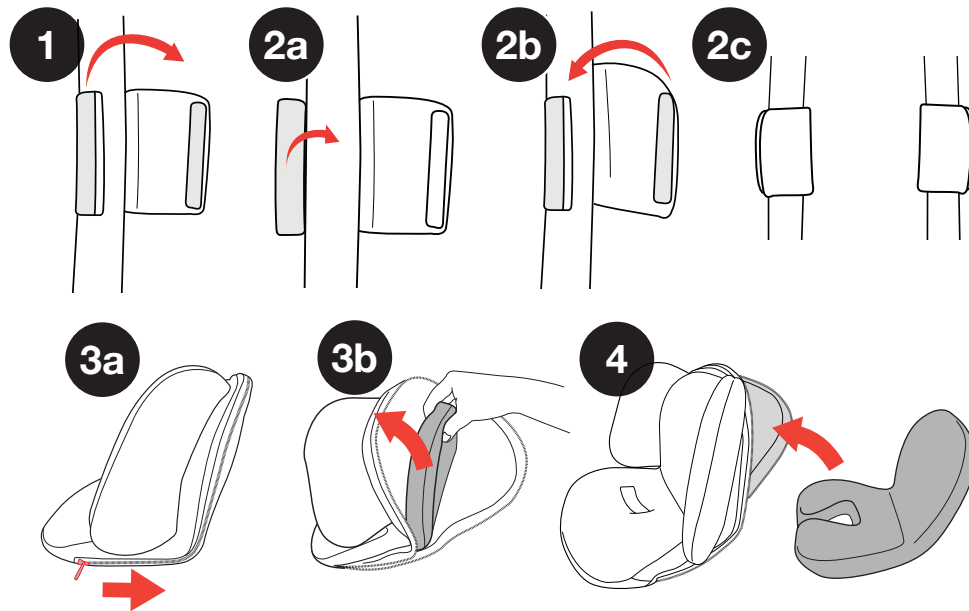



**5 REMOVING FLEX-FORWARD CROTCH PAD:**

Undo the snap button and pull the strap out from the Harness Buckle Strap (a).

Pull the Harness Buckle down, and at the same time pull up on the Flex-Forward Crotch Pad to remove (b).

See page 40 to install Flex-Forward Crotch Pad.

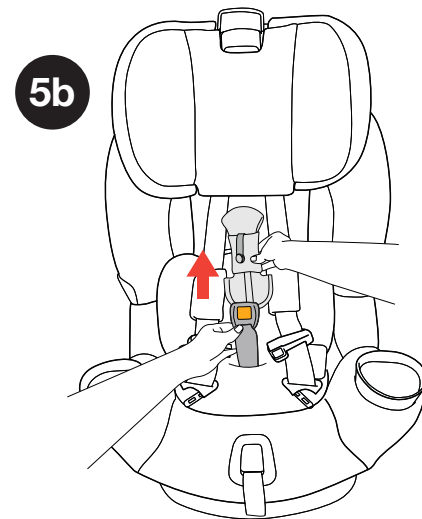
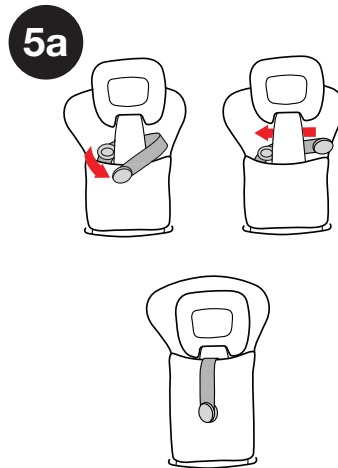

**SOFTGOODS REMOVAL:**

Before you start, make sure Shoulder Pads, Waist Belt Pads, Flex-Forward Crotch Pad, Newborn Head and Body Positioner, and Cup Holders are removed. Also, undo the Harness Buckle and Chest Clip.

- 6** Adjust Head Rest to its highest position (a). At the back of the Head Rest undo both snap buttons (b). Pull the Head Rest fabric forward off of sides of the Head Rest frame. Then undo both snap buttons below the Head Rest (c).
- 7** Slide the Head Rest fabric down off of the Back Rest plate.

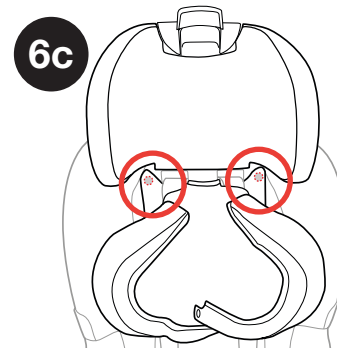
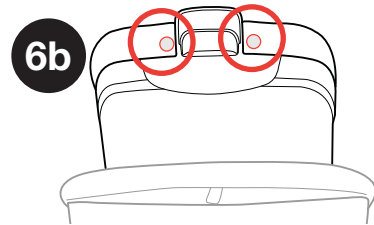
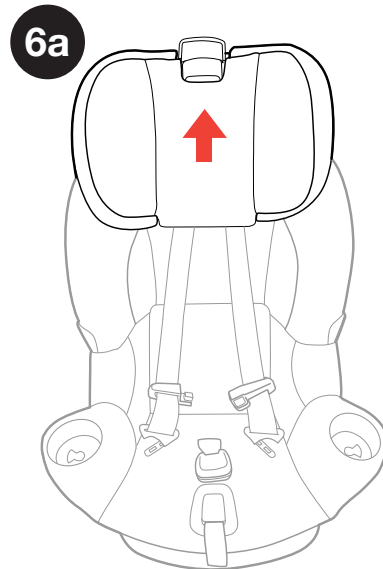

## CLEANING AND MAINTENANCE

**SOFTGOODS REMOVAL:**

- 8** Adjust Head Rest to its lowest position (a). At the back of the Child Restraint locate the fabric loop (b). Pull up and forward on the seat padding. Then guide around the Head Rest and off the seat back frame.
- 9** Pull the front edge of the seat padding up and guide the seat padding from around the Harness Release Button.

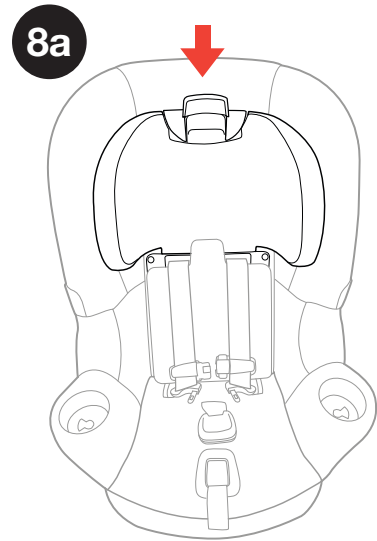

## CLEANING AND MAINTENANCE

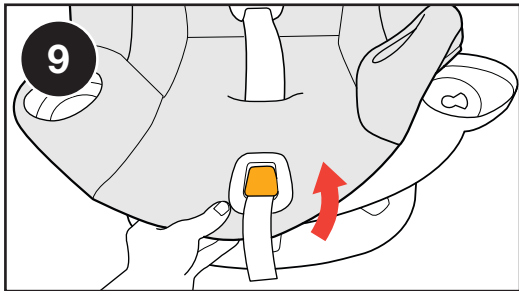
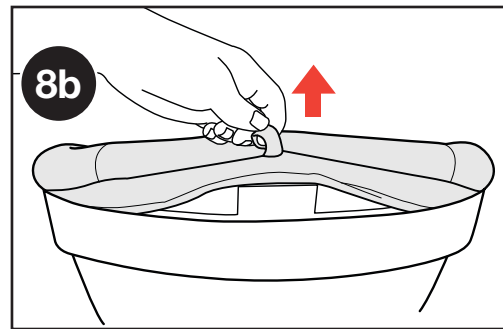

**SOFTGOODS REMOVAL:**

- 10** At both sides of the seat frame, pull down the edge of the seat padding (a). Then guide the padding off and around the frame above the Seat Release Handle (b). Remove the Seat pad.

**INSTALL SOFTGOODS:**

- 11** Reverse the removing instructions above to reinstall. Scan QR Code on the back of this guide or visit [ChiccoFit360.com](http://ChiccoFit360.com) for Instruction Videos.

**⚠ NEVER use Child Restraint without the Seat Pad.**

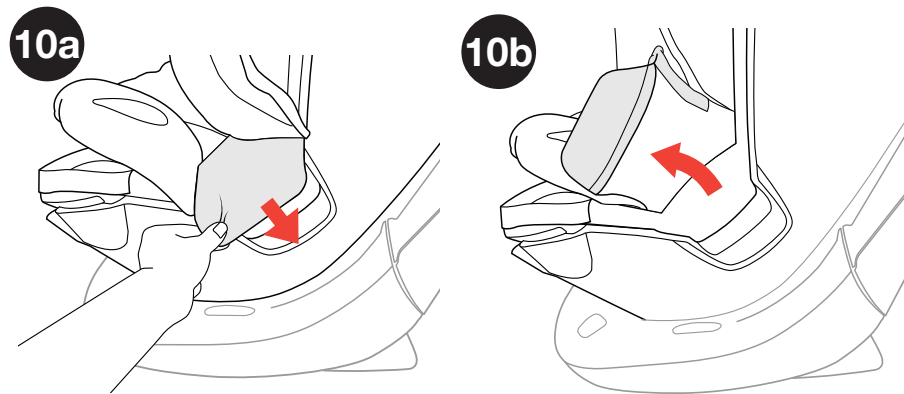

**REMOVING CROTCH STRAP:**

- 1 Make sure the Crotch Strap is in Position 1 (a). Allow the Crotch Strap Bar to drop down into the seat Base. Turn the Crotch Strap sideways while the Crotch Strap Bar is lowered. Then rotate the Crotch Strap Bar up through Position 2 (b). Remove the Crotch Strap.

⚠ NEVER use Child Restraint without the Crotch Strap installed.

**INSTALL CROTCH STRAP:**

- 2 Reverse the removing instructions above to reinstall.

⚠ DO NOT USE Child Restraint if any part of the harness is damaged. For proper removal and installation of the harness straps visit the Chicco website at [www.chiccouusa.com](http://www.chiccouusa.com) or call 1-877-424-4226.

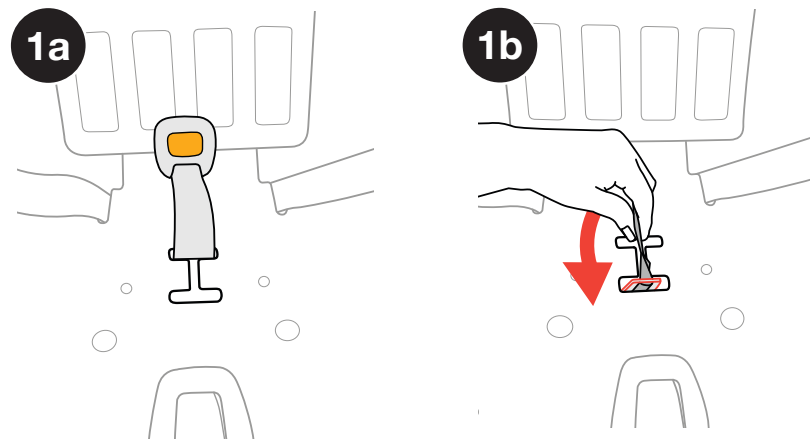

## CLEANING AND MAINTENANCE

⚠ DO NOT USE BLEACH, solvents or household cleaners as they may weaken plastics and straps.

⚠ DO NOT USE SOAPS OR LUBRICANTS on Harness Adjuster Strap, Buckle and LATCH hardware. It may cause them to malfunction.

- **Cleaning Soft Goods:**

Hand wash using mild soap and water, or machine washed in cold water on delicate cycle using mild detergent. Hang to dry. See page 108 for removal instructions.

⚠ **NEVER** use Child Restraint without the seat pad.

- **Cleaning Shoulder Pads:**

Hand wash using mild soap and water. Hang to dry.

- **Cleaning Plastics:**

Sponge clean using warm water and mild soap. Towel dry.

## CLEANING AND MAINTENANCE

- **Cleaning Cup Holder:**

Cup Holder is dishwasher safe on top rack only.

⚠ **DO NOT USE** Child Restraint if any part of the harness is damaged. For proper removal and installation of the harness straps visit the Chicco website at [www.chiccousa.com](http://www.chiccousa.com) or call 1-877-424-4226.

- **Cleaning Harness:**

Sponge clean using warm water and mild soap. Air dry. Do NOT machine wash.

- **Cleaning LATCH and Adjuster Strap:**

LATCH Straps cannot be replaced. Sponge clean using warm water only. Air dry.

- **Cleaning Buckle and LATCH Hardware:**

Sponge clean, using warm water only. If debris in buckle, remove and rinse in warm cup of water. Air dry. See page 118 for removal instructions.



Do **NOT** remove LATCH or Adjuster straps. For additional information visit the Chicco website at [www.chiccousa.com](http://www.chiccousa.com) or call 1-877-424-4226.

[ **Kee-Ko** ] If you say it right it makes you *smile*



SCAN HERE  
LEARN HOW TO  
INSTALL & USE  
**FIT360**

