



ONEFIT™ LX

All-In-One Car Seat

For future use, store user guide
in compartment at rear of base.

IS0235E_05 02/24 ©2024 Artsana USA, Inc.
ChiccoUSA.com



User Guide

If you have any problems with your Chicco Child Restraint, or any questions regarding installation or use, please call:

Chicco Customer Service
1-877-424-4226

Please have Model and Serial Number available when you call. These are located on a label on the bottom of the Child Restraint.

For future reference, fill in the information below. The information can be found on the label on the bottom of the Child Restraint.

Model Number: _____

Serial Number: _____

Manufactured In: _____

TABLE OF CONTENTS

Registration and Recall	2	REAR-FACING INSTALLATION	
Child Guidelines	4	Rear-Facing Setup	50
Safe Use Checklist	6	Install Using LATCH	54
Important Warnings	8	Install Using LAP-SHOULDER BELT	60
Best Practices	14	Install Using LAP BELT ONLY	64
Need Help?	15	FORWARD-FACING INSTALLATION	
CHILD RESTRAINT OVERVIEW		Forward-Facing Harness Mode Setup	68
Child Restraint Components	16	Install Using LATCH	72
Insert Components	18	Install Using LAP-SHOULDER BELT	78
LATCH and Tether Components/Storage	20	Install Using LAP BELT ONLY	90
Selecting Rear/Forward-Facing/Booster	24	SECURING YOUR CHILD	
Cup Holder	30	Securing Child with Harness	98
Crotch Strap Pad	32	Securing Child Checklist	110
Adjusting Crotch Strap	34	BOOSTER INSTALLATION	
Newborn Positioner	38	Booster Mode Setup	112
VEHICLE INFORMATION		Booster Mode Installation	120
Vehicle Seating Positions	40	Securing Child in Booster Mode	126
Vehicle Seat Belts	42	Convert to Harness Mode	132
What is LATCH?	46	Securing Child Checklist	134
What is a Tether?	48	ADDITIONAL INFORMATION	
		Installation on an Aircraft	136
		Cleaning and Maintenance	138

Please complete the Registration Card that came with your Child Restraint and mail it promptly.

Child Restraints could be recalled for safety reasons. You must register this restraint to be reached in a recall. Send your name, address, e-mail address if available, and the restraint's model number and manufacturing date to:

Artsana USA, Inc.
1826 William Penn Way
Lancaster, PA 17601
or call 1-877-424-4226

or register online at <http://www.chiccousa.com/carseatregistration.aspx>

For recall information, call the U.S. Government's Vehicle Safety Hotline at 1-888-327-4236 (TTY: 1-800-424-9153), or go to www.NHTSA.gov.

PAGE INTENTIONALLY LEFT BLANK

CHILD GUIDELINES

This Child Restraint is designed for children ages Birth to 10 years old. **ONLY** use this Child Restraint if the child meets **BOTH** of the following Weight and Height requirements:

- **Weight is between 5 and 100 pounds (2.3 and 45.3 kg).**
- **Height is 57 inches (145 cm) or less.**

The Newborn Positioner is only for infants who weigh between 5 and 11 pounds (2.3 and 5 kg). See Newborn Positioner on page 38.

⚠ For premature infants, you must consult the infant's doctor before using this Child Restraint. A premature infant may have difficulty breathing or have other medical problems when placed in a seated position.

CHILD GUIDELINES

See Select Rear-Facing on page 24.

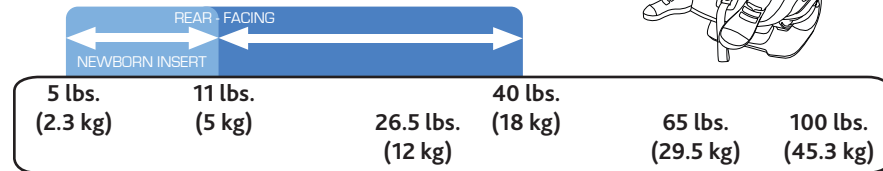

See Select Forward-Facing Harness Mode on page 26.

Or Forward-Facing Booster Mode on page 28.

SAFE USE CHECKLIST

⚠ YOUR CHILD'S SAFETY DEPENDS ON YOU! You MUST follow the detailed instructions in this User Guide to ensure the steps below are performed correctly!

- Make sure your child meets the age, weight, and height requirements:**
Refer to the "Child Guidelines" section on page 4.

- Choose the proper Child Restraint configuration:**

REAR-FACING requirements on page 25

FORWARD-FACING HARNESS MODE requirements on page 27

FORWARD-FACING BOOSTER MODE requirements on page 29

- Select a safe seating location in your car:**
Refer to the "Vehicle Seating Positions" section on page 40 and 41.



SAFE USE CHECKLIST

- Ensure that the Child Restraint is properly leveled when installed:**

REAR-FACING requirements on page 50

FORWARD-FACING HARNESS MODE requirements on page 68

FORWARD-FACING BOOSTER MODE requirements on page 112

- Check Child Restraint for a snug fit in your car:**
While holding Child Restraint near belt path used, pull side to side and forward. Belt should remain tight and Child Restraint should not move more than 1" (25 mm) from vehicle seat back or side-to-side.
- Secure your child:**
Refer to the "Securing Your Child" section on page 98 and 126.



FAILURE TO FOLLOW THESE INSTRUCTIONS AND THE PRODUCT LABELS CAN RESULT IN SERIOUS INJURY OR DEATH TO YOUR CHILD.

Take Time to Read This User Guide

- Carefully read and understand all instructions and warnings in this User Guide. Your child's safety depends on you knowing how to setup, install and use this Child Restraint properly.
- Before installing this Child Restraint in a vehicle, be sure to also check the vehicle owner's manual for information on proper installation.
- **NEVER** allow others to use this Child Restraint until they have read and understood all instructions in this User Guide.
- This Child Restraint is not intended for use outside of the vehicle.

Make Sure Child Fits This Child Restraint

- Use only with children who weigh between 5 lbs (2.3 kg) and 100 lbs (45.3 kg) and whose height is 57 inches (145 cm) or less. Determine the right installation setup for your child's age, weight and height.
- **ONLY USE** the Newborn Positioner REAR-FACING and only if the child weighs between 5 and 11 lbs (2.3 and 5 kg).



Secure Child Properly

- Snugly adjust the harness around your child. A loose harness could cause the child to be ejected in a sudden stop or crash, resulting in serious injury or death.

A snug strap should not allow any slack. It lies in a relatively straight line without sagging. It does not press on the child's flesh or push the child's body into an unnatural position.

- **NEVER** use clothing or blankets that interfere with fastening or tightening the harness. An unsecured child could be ejected in a sudden stop or crash!

To keep child warm, place a blanket over child and restraint AFTER you have properly secured child in harness.

- **ALWAYS** check to make sure buckle is securely latched. If buckle separates, child could be killed or seriously injured.
- **NEVER** leave child unattended. Do not allow children to play in or around the Child Restraint.
- **ALWAYS** keep child properly secured in harness whenever child is in Child Restraint.
- When installing the seat forward-facing with the vehicle's lap or lap and shoulder belt system, always make sure the vehicle belt is routed and secured with the LeverLock® mechanism.



Install Child Restraint Correctly

- **WHEN USING THIS CHILD RESTRAINT REAR-FACING, DO NOT PLACE THIS CHILD RESTRAINT IN VEHICLE SEATING LOCATION WITH A FRONTAL AIR BAG, UNLESS THE AIR BAG CAN BE TURNED OFF.** If the airbag inflates, it can cause serious injury or death to your child. For vehicles with side air bags, refer to your vehicle owner's manual for information on your Child Restraint installation.
- **ALWAYS** install this Child Restraint in a back seat if possible.

According to accident statistics, children are safer when properly restrained in the rear seating positions rather than in the front seating positions.

- **NEVER** install on a rear-facing or side-facing vehicle seat, or on the back of a folded down vehicle seat.
- **ALWAYS** secure this Child Restraint with the vehicle's Child Restraint anchorage system (LATCH) if available OR the vehicle seat belt. Refer to Page 5 for proper use/child weight limits when installing with LATCH.
- **DO NOT** use the lower anchors of the Child Restraint anchorage system (LATCH system) to attach this Child Restraint **REAR-FACING** when restraining a child weighing more than **35 lbs (15.9 kg)** or **FORWARD-FACING** with the internal harness when restraining a child weighing more than **40 lbs (18 kg)**.
- **WARNING!** Use only the vehicle's lap and shoulder belt system when restraining the child in this booster seat.



Install Child Restraint Correctly

- **ALWAYS** use the top tether strap on this Child Restraint when installed FORWARD-FACING, if a tether anchor is available. **NEVER** use the top tether strap on this child restraint when installed REAR-FACING.
- **NEVER** use Child Restraint in a vehicle seating position where it cannot be secured tightly when installed for harness mode. A loosely installed Child Restraint will not protect your child in a crash.
- **Never leave Child Restraint unsecured in your vehicle even when it is unoccupied.** It could injure other occupants in a sudden stop or crash.
- **DO NOT** install this Child Restraint using an inflatable seat belt. The interaction of the inflatable portion of the vehicle's belt with this Child Restraint **can result in serious injury or death.** Install using LATCH instead, or move the Child Restraint to a position with a suitable seat belt type. Refer to your vehicle owner's manual for instructions for use in Booster Mode.

Ensure Child's Safety When Using Child Restraint

- **NEVER leave your child unattended in the vehicle.**
- **STRANGULATION HAZARD:** Your child can strangle in a loose Restraint Harness. Never leave a child in the Child Restraint with straps loose or undone.
- To **prevent ejection or breathing difficulties, proper recline is required.** When installing the Child Restraint, check the bubble level on the side of the Child Restraint.



Check Condition of Restraint

- **DO NOT** use if the Harness or LATCH straps are cut, frayed or damaged.
- **DO NOT use this Child Restraint if it is more than 10 years old.** Check manufacturer's label on underside of Child Restraint for the "Do Not Use After" date.
- **DO NOT use any accessories, pads or products not included with this Child Restraint, unless approved by Chicco USA.** Doing so will void the warranty of this Child Restraint.
- **You MUST replace this Child Restraint if it has been involved in a crash, even if you cannot see visible damage.** A damaged Child Restraint may not protect your child in a future crash.
- **Do not modify your Child Restraint.**
- **NEVER** remove harness from Child Restraint without the proper removal and installation instructions available from Chicco USA. Contact us by visiting the Chicco website at www.chiccousa.com or call 1-877-424-4226.
- **Do not use Child Restraint if any component is damaged, broken, or missing parts.** Call 1-877-424-4226 to find out if the damaged part or parts can be replaced.

PAGE INTENTIONALLY LEFT BLANK

- Ensure all vehicle occupants are properly restrained before traveling. Unrestrained occupants can be thrown around and may be seriously injured or seriously injure other occupants in a sharp turn, sudden stop or crash.
- Do not leave loose objects, such as books, bags, etc., in the back of the vehicle. In the event of a sharp turn, sudden stop, or crash, loose objects can be thrown around and possibly cause serious injury to vehicle occupants.
- Cover the Child Restraint when the vehicle is parked in sunlight. Parts of a Child Restraint can become very hot if left in the sun. Contact with these parts can burn a child's skin. Always check the surface of any metal or plastic parts before putting your child in the Child Restraint.
- To avoid strangulation, Do not allow children to play with vehicle seat belts. If possible, move unused belts out of reach.
- Do not use anything to raise the Child Restraint off the vehicle seat such as a noodle or towel. In a sharp turn, sudden stop, or crash, the Child Restraint could slide and potentially cause serious injury.
- Never use a second-hand Child Restraint with an unknown history.
- Never use any accessories that are not included with this Child Restraint, unless specifically approved by Chicco. For more information, go to www.chiccousa.com.

Need Help Securing Your Child Restraint?

The following sources are available to help ensure your Child Restraint is properly installed:

- Contact Chicco, USA by visiting our website at www.chiccousa.com or calling our Customer Service 1-877-424-4226. Please have Model and Serial Number available when you call. These are located on a label on the bottom of the Child Restraint.
- Refer to your vehicle manual for Child Restraint installation tips.
- Contact a certified Child Passenger Safety Technician in your area by visiting safercar.gov and select "Find Local Child Seat Help" or call 1-866-SEAT CHECK (1-866-732-8243).

CHILD RESTRAINT COMPONENTS

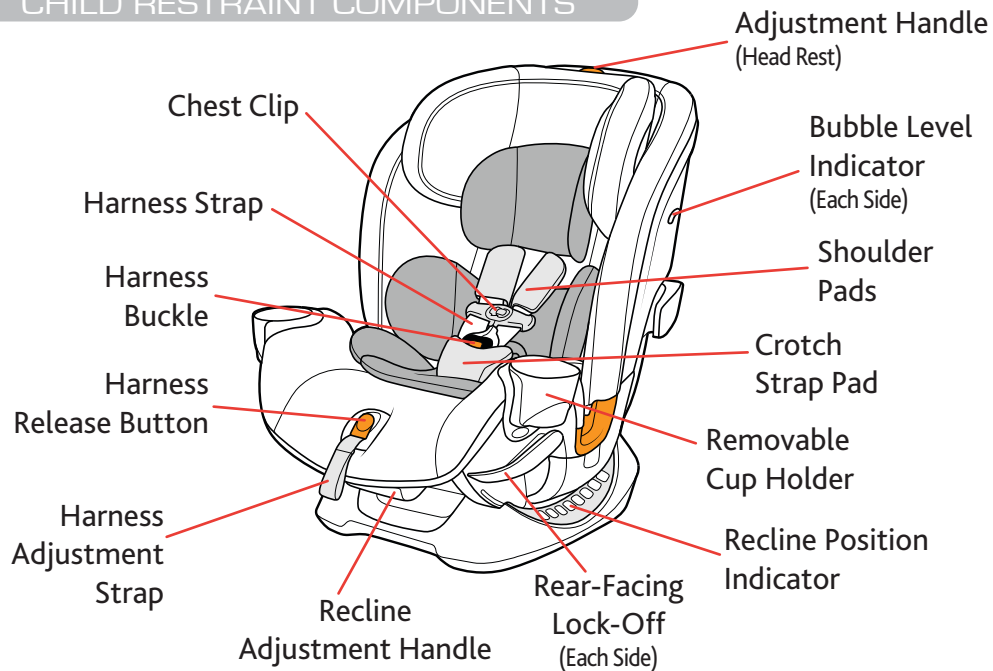

CHILD RESTRAINT COMPONENTS

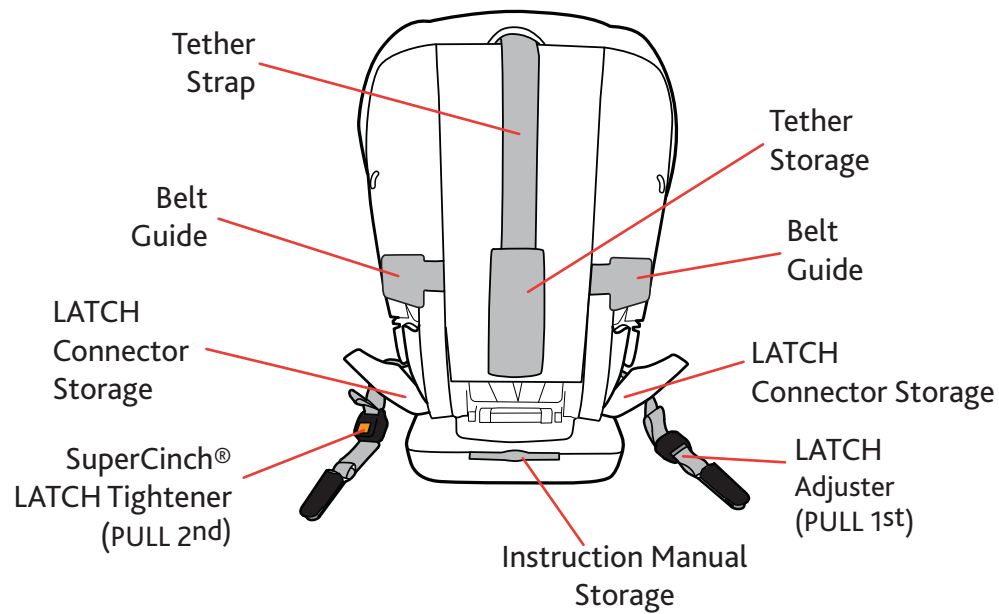

INSERT USE:

- 1 Newborn Positioner

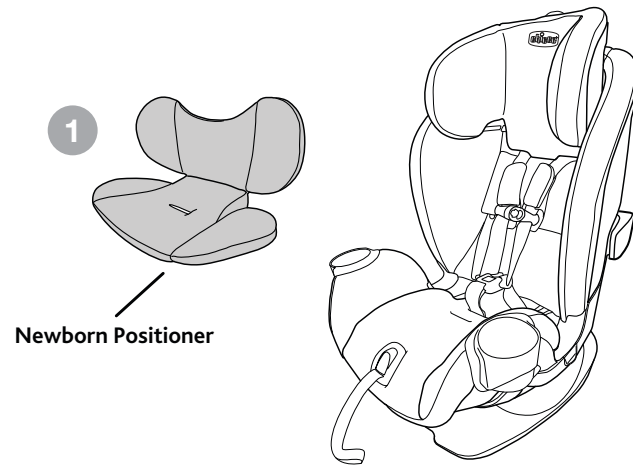

LATCH AND TETHER COMPONENTS

TETHER:

- A** Tether Strap
- B** Tether Strap Adjuster
- C** Tether Hook

LATCH:

- D** LATCH Adjuster (PULL 1st)
- E** SuperCinch® LATCH Tightener (PULL 2nd)
- F** LATCH Strap
- G** LATCH Connectors

LATCH AND TETHER COMPONENTS

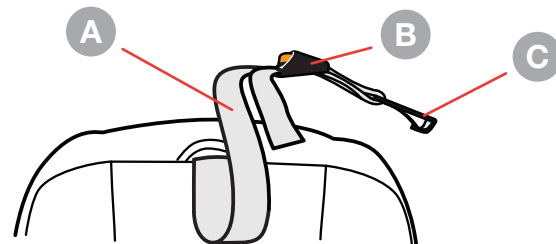
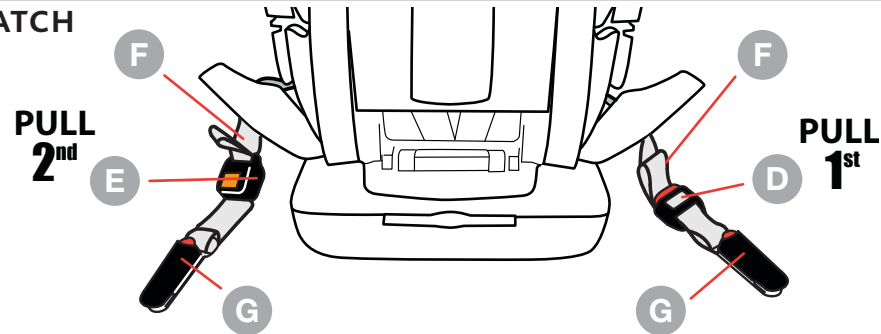
**Tether****LATCH**

LATCH AND TETHER STORAGE

⚠ Always make sure LATCH Components are properly stored in the compartments when not in use.

LATCH STORAGE:

- 1 Store each LATCH strap in the compartments located on either side of the Child Restraint base when not in use. Make sure Lower Anchor Connector Storage compartments are properly closed.

Fold SuperCinch® LATCH Tightener (Pull 2nd) strap as shown (1a).

TETHER STORAGE:

- 2 Store Tether in the compartment in the back of Child Restraint when not in use. Hook on bar and pull strap to remove slack. Make sure compartment door is properly closed.

LATCH AND TETHER STORAGE

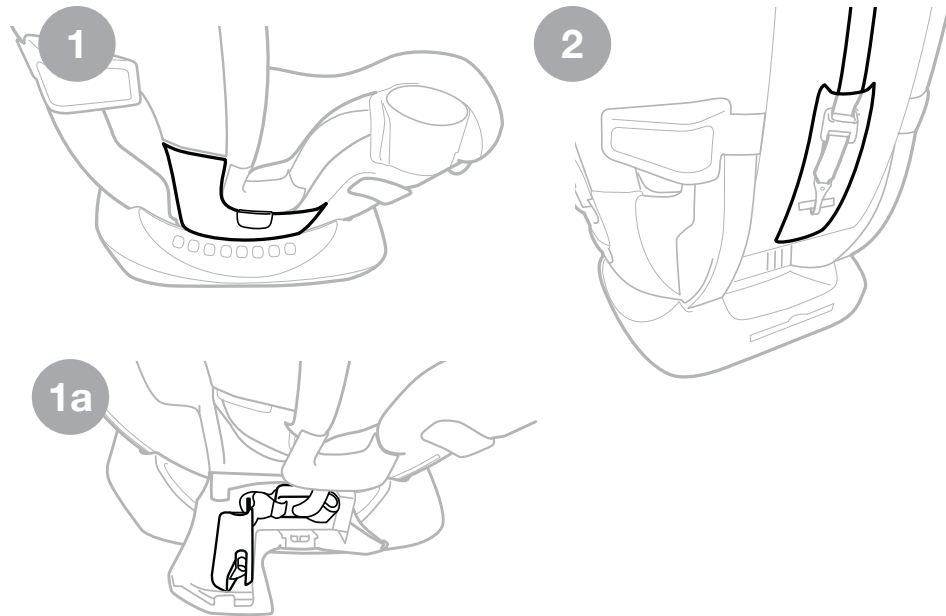

SELECT REAR-FACING MODE

⚠ WARNING! REAR-FACING use of this Child Restraint is ONLY for children who meet ALL of the requirements shown here. If the child is not within these requirements because the child is too large, review the **FORWARD-FACING HARNESS MODE** guidelines on page 26.

⚠ NEVER turn this Child Restraint FORWARD-FACING with an infant less than one year of age.

SELECT REAR-FACING MODE

REAR-FACING:

With Newborn Positioner:
5 – 11 lbs (2.3 – 5 kg)

Without Newborn Positioner:
11 – 40 lbs (5 – 18 kg)

Use **REAR-FACING** with children:

- Who weigh between 5 and 40 lbs (2.3 – 18 kg).
- Who are no taller than 43" (109 cm).
- When Harness Straps can be positioned at or below the child's shoulders*.

See Harness Height Adjustment on page 102.

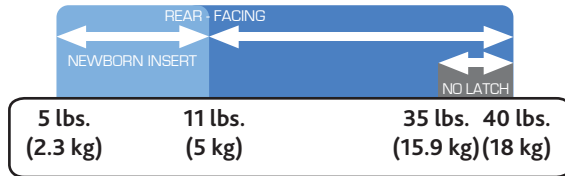

SELECT FORWARD-FACING MODE

⚠ WARNING! FORWARD-FACING HARNESS MODE use of this Child Restraint is **ONLY** for children who meet **ALL** of the requirements shown here. If the child is not within these requirements because the child is too small, review the **REAR-FACING** guidelines on page 24. If the child is not within these requirements because they are too large, review the **BOOSTER MODE** guidelines on pg 28.

⚠ NEVER turn this Child Restraint **FORWARD-FACING** with an infant less than one year of age.

SELECT FORWARD-FACING MODE

FORWARD-FACING HARNESS MODE:
26.5 – 65 lbs (12 – 29.5 kg)

Use **FORWARD-FACING HARNESS MODE** with children:

- Who are at least one year old.
- Who weigh between 26.5 and 65 lbs (12 – 29.5 kg).
- Who are no taller than 54" (137 cm) **OR** when the top of the ears are below the top of the Head Rest.
- When Harness Straps can be positioned at or above the child's shoulders*.

See Harness Height Adjustment on page 102.

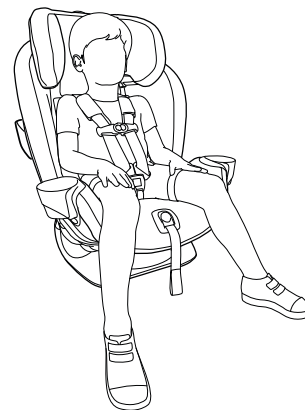
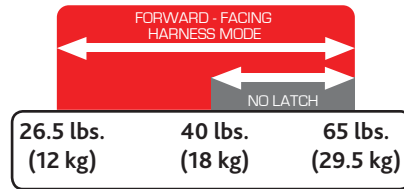
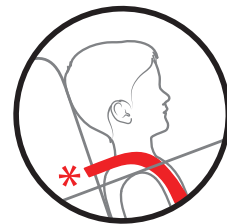

SELECT BOOSTER MODE

⚠ WARNING! **BOOSTER MODE** use of this Child Restraint is ONLY for children who meet ALL of the requirements shown here. If the child is not within these requirements because the child is too small, review the **FORWARD-FACING HARNESS MODE** guidelines on page 26.

SELECT BOOSTER MODE

BOOSTER MODE:
40 – 100 lbs (18 – 45.3 kg)

Use **BOOSTER MODE** with children:

- Who are at least four years old.
- Who weigh between 40 and 100 lbs (18 – 45.3 kg).
- Who are 38" to 57" (97 - 145 cm) tall.
- Who demonstrate an ability to sit relatively still and properly in a seat belt at all times.

See Adjusting Shoulder Belt Guide Height on page 126.

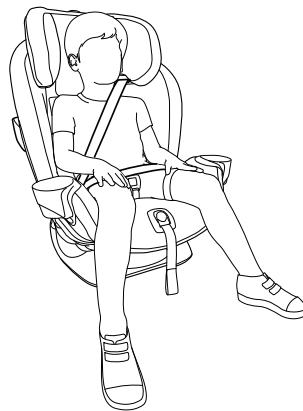
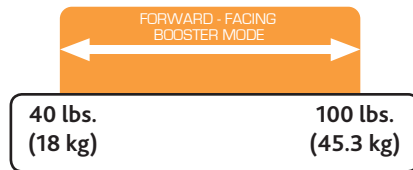

⚠ WARNING - Do NOT use Cup Holder to hold hot liquids. **PLASTIC CONTAINERS ONLY** - No glass or metal containers. Only use cups with less than 12 oz. (355 ml) capacity. Never place sharp or pointed objects in Cup Holder. In a crash these objects could hit you or your child and cause serious injuries.

ATTACHING THE CUP HOLDER:

- 1 Match the "R" and "L" Cup Holders to the Child Restraint, as shown.
- 2 Make sure the fabric is tucked in along the Child Restraint lip to allow the Cup Holder to be attached properly. Line up the Cup Holder pin and the two guides with the openings on the Child Restraint, as shown. Push in and then push down on the Cup Holder until it clicks into place. Repeat for the other side.

REMOVING THE CUP HOLDER

- 3 To remove, press the button located on the bottom edge of the Cup Holder. Lift up to remove.

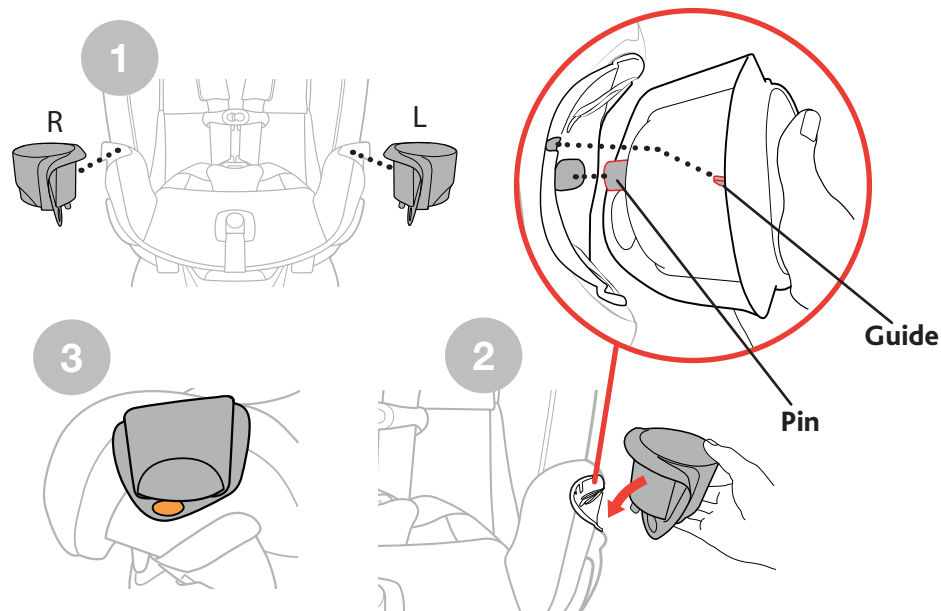

CROTCH STRAP PAD

- 1 Slide the Harness Buckle up through the Crotch Strap Pad.
- 2 Push the Fabric Tab into the slot in the top layer of padding.

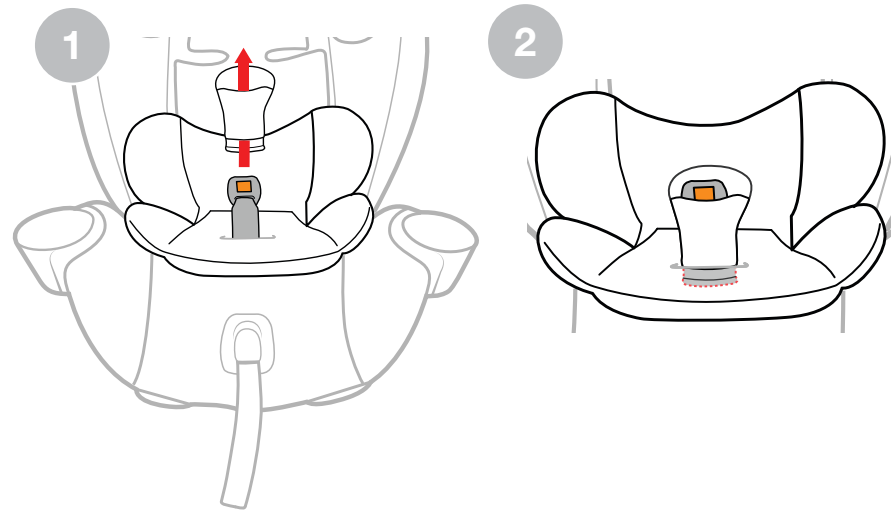

ADJUSTING CROTCH STRAP

Adjust Crotch Strap if strap is underneath child. When moving the Child Restraint from rear-facing mode to forward-facing mode, the crotch strap must be adjusted to the front position.

Back Position

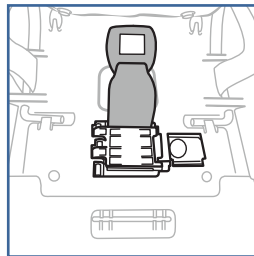

Front Position

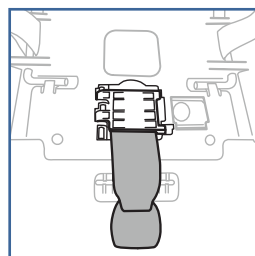

- 1 Unbuckle Harness Straps. Remove Crotch Strap Pad and Cup Holders (Refer to page 138 and 30). Undo the elastic straps on each side (a). Pull out the seat pad fabric edges at the front of the seat and sides. Lift up the seat pad and guide it around and off the adjustment strap (b). Push the seat pad fabric towards the seat back.

ADJUSTING CROTCH STRAP

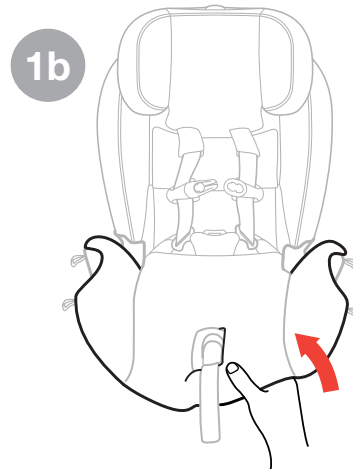
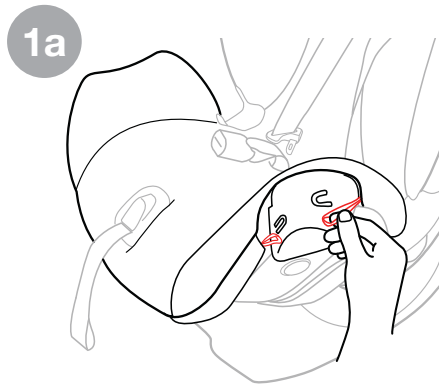

ADJUSTING CROTCH STRAP

- 2 Slide the orange button on the Crotch Strap lock while pulling up on the Crotch Strap to open the compartment (a,b). Then pull the Crotch Strap forward or backward into desired position (c).
- 3 Close the compartment by pushing down on the door until it locks back into place. Check to make sure compartment is locked by pulling up on the Crotch Strap. Re-attach the seat pad.

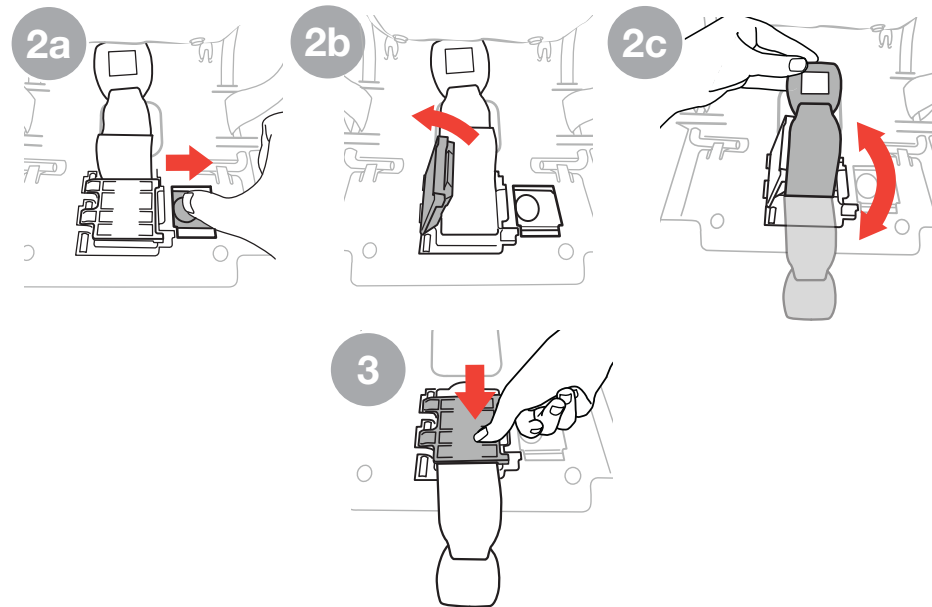

NEWBORN POSITIONER

⚠ WARNING - ONLY use the Newborn Positioner if the child weighs between 5 and 11 lbs (2.3 and 5 kg).

To ensure a better fit for smaller infants, the Newborn Positioner must be used. Do NOT use any other infant insert or pillows. Only use those provided by Chicco for this Child Restraint.

- 1 Pull both Harness Straps over the side panels of Newborn Positioner.
- 2 Push Newborn Positioner firmly into Child Restraint to make sure it is properly positioned.
- 3 Lift up on the Newborn Positioner and pull Crotch Strap Pad through slot (a). Thread the Harness Buckle up through the slot in the Newborn Positioner and Crotch Strap Pad (b). Make sure the fabric tab on the bottom of the Crotch Strap Pad is tucked into the slot of the Newborn Positioner.

NEWBORN POSITIONER

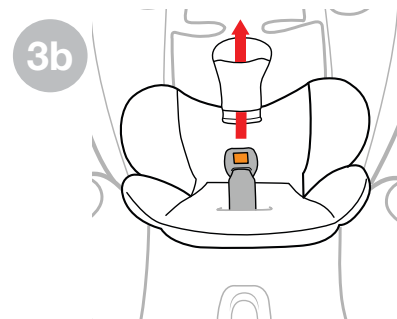
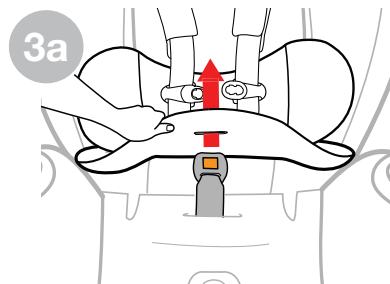
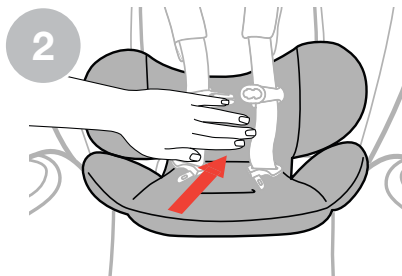
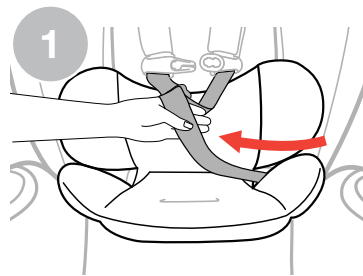

VEHICLE SEATING POSITIONS



⚠ WARNING! WHEN USING THIS CHILD RESTRAINT REAR-FACING, DO NOT PLACE THIS CHILD RESTRAINT IN A VEHICLE SEATING LOCATION WITH A FRONTAL AIR BAG, UNLESS THE AIR BAG CAN BE TURNED OFF.

The back seat is the safest place for children 12 and under. See your vehicle owner's manual for Child Restraint installation and instructions.

VEHICLE SEATING POSITIONS

Some vehicles have no seating positions which are compatible with this Child Restraint. If in doubt, contact the vehicle manufacturer for assistance. Only forward-facing vehicle seats should be used with this Child Restraint.



Do not use on a folded down vehicle seat back.

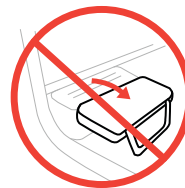

Make sure no more than 3 inches (76 mm) of the Child Restraint Base is past the edge of the vehicle seat.

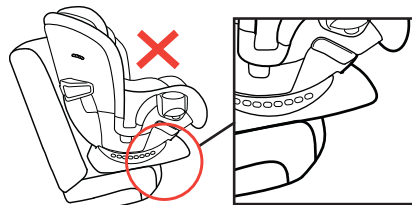

When using the seat as **BOOSTER**, always install in a vehicle seat with a 3-point seat belt (shoulder belt and lap belt). **NEVER** use lap belt only.



The information in this section applies to installation with **REAR-FACING** and **FORWARD-FACING HARNESS MODE** vehicle seat belts only.

For simplest installation use **LATCH** - Refer to page 46 for details.

Vehicle seat belts differ from vehicle to vehicle. Refer to your vehicle owner's manual for specific information about seat belts and their use with Child Restraints.

Shoulder belt with switchable retractor:

Putting the shoulder belt in the locked/switched mode as the last step is optional. The shoulder belt Lock-Off replaces the need for the locked/switched mode. When the Child Restraint is rear-facing using the locked/switched mode may cause Child Restraint to tilt.

The following types of vehicle belts **MUST NOT** be used to install this Child Restraint. If any of the belt types listed below are in the chosen seating position, choose another vehicle seating position or use LATCH if available.

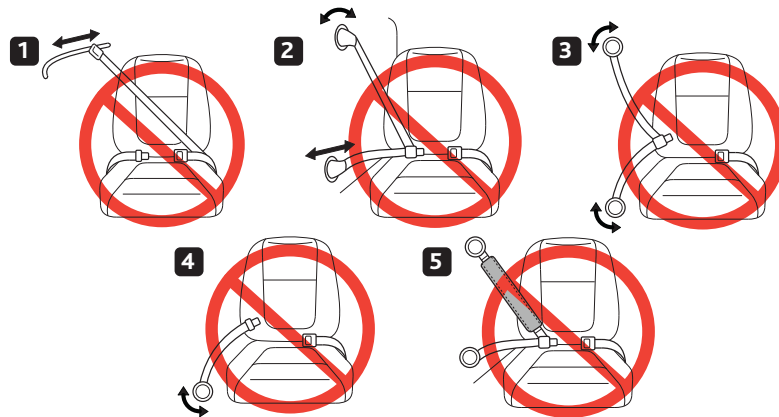

1. Motorized (automatic) vehicle belts.
2. Door mounted vehicle belts.
3. Lap-shoulder Belts with 2 retractors (unless Lap Belt has a "Lock Mode").
4. Non-Locking (ELR) Lap Belts.
5. Inflatable seat belts.

The information in this section only applies to installation with vehicle seat belts in **BOOSTER MODE**.

Shoulder belt with switchable retractor:

Refer to your vehicle owner's manual for information regarding switchable retractors and Booster Seat use.

Inflatable seat belts:

Refer to your vehicle owner's manual for instructions for use with this Booster Seat.

The following types of vehicle belts **MUST NOT** be used to install this Child Restraint in **BOOSTER MODE**.

If any of the belt types listed below are in the chosen seating position, you must choose another vehicle seating position.



1. Never use a Lap Belt with motorized Shoulder belt.

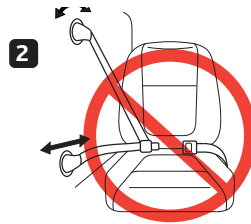

2. Never use vehicle belts that are attached to the door or that move along a track.



3. Never use any type of Lap-Only Belt.

⚠ WARNING: This Child Restraint is designed to be used with lower anchors at the standard spacing (11 inches (28 cm)) **ONLY!** Refer to vehicle owner's manual for information about LATCH and Child Restraint installation positions.

LATCH = Lower Anchors and Tethers for Children

United States Motor Vehicle Safety Standards have defined a system for installing Child Restraints in vehicles called LATCH. **LATCH may ONLY be used IN PLACE OF vehicle belt if the vehicle is equipped with LATCH anchor points. DO NOT use both the seat belt and LATCH at the same time. Please refer to the vehicle owner's manual for designated LATCH locations in vehicles.**

LATCH in the vehicle consists of a top tether anchor point and two lower anchor points. Some vehicles owner's manual use the term "**ISOFIX**". **LATCH** can also be used in vehicle seating positions equipped with **ISOFIX**.

If the vehicle is equipped with **LATCH**, the vehicle lower anchor points may be visible at the seat crease. If not visible, the seating position may be marked with a symbol (fig. a) or a colored dot. Check the vehicle owner's manual for vehicle top tether anchor locations. They may be identified using one of the anchor symbols (fig. b or fig. c).

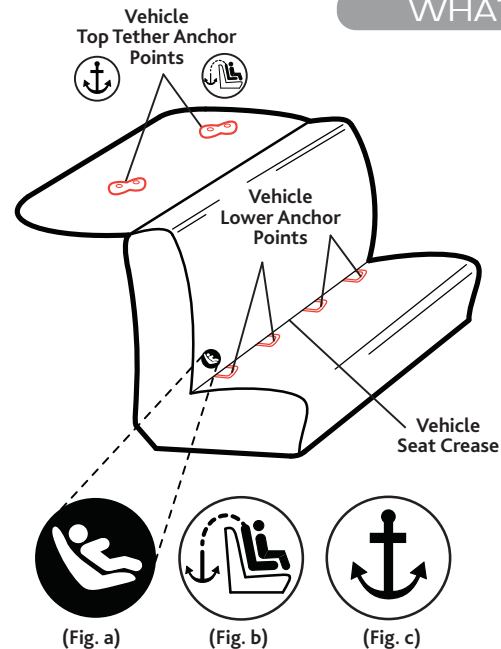

WHAT IS A TETHER?



The tether is a strap on your Child Restraint that connects to a tether anchor in your vehicle. Tether anchor locations vary from vehicle to vehicle. Check your vehicle owner's manual and look for the tether anchor symbol as shown. A tether reduces movement of a forward-facing Child Restraint in a crash and helps to achieve a tight installation.

Vehicle tether anchors can be found in many different locations. Some of the typical locations are shown on the next page. Refer to your vehicle owner's manual for exact locations, anchor identification, and requirements.

WHAT IS A TETHER?

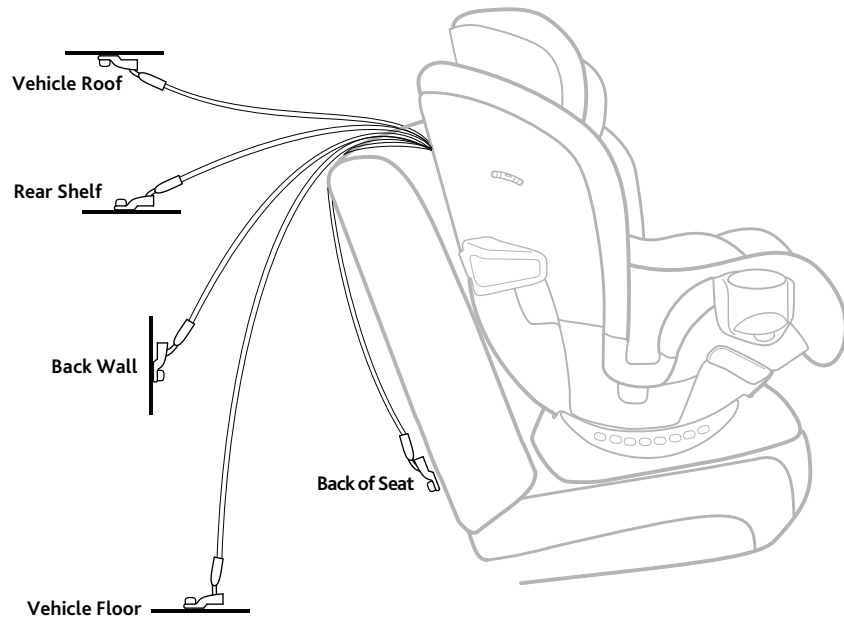

REAR-FACING SETUP

⚠ Infants may have difficulty breathing when in a sitting position. Make sure the seat is reclined properly so that your child's head does not fall forward. **Failure to properly recline the Child Restraint could increase the child's risk of serious injury or death.**

- 1 See page 40 for "Vehicle Seating Positions" before installing. Make sure the vehicle is on a level surface, if possible.



- 2 Squeeze the Recline Adjustment Handle on front of Child Restraint and pull forward to adjust to a reclined position as shown (a).

If a change in recline position is necessary after Child Restraint is installed, loosen the current method of installation and adjust the recline. Repeat installation steps and refer to pages 51-67 to ensure Child Restraint is installed correctly.

REAR-FACING SETUP

Do not use Tether in REAR-FACING mode. Tether must be properly stored - See "Tether Storage" Pages 22-23

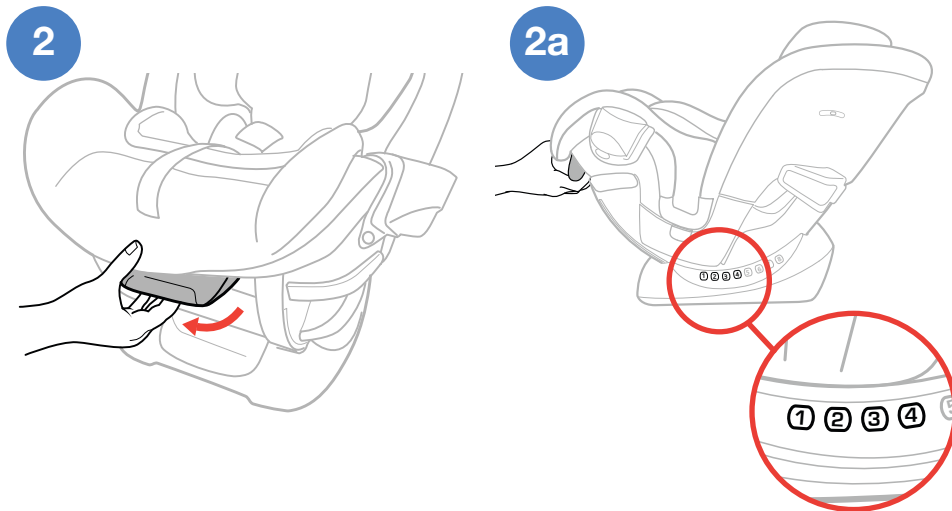

REAR-FACING SETUP

3 Place Child Restraint rear-facing on selected vehicle seat. Make sure it is not blocking the vehicle belt buckle. Push the Child Restraint back until it touches the vehicle seat back and make sure the base stays flat on the vehicle seat. Do not exceed the rear-facing maximum base overhang of 3 inches (76 mm) over the front edge of the vehicle seat.

4  **Installation on a Level Surface:** Locate the Bubble Level Indicator label and re-adjust the seat recline to any position that the Bubble falls between the correct **Rear-Facing** lines.

 **Installation on a Slope:** Locate the Level Line on the blue label near the rear-facing belt path. Adjust the seat recline so that the Level Line is level with the ground.

Installation Options:

- *LATCH installation continued on page 54.*
- *Lap-Shoulder Belt installation continued on page 60.*
- *Lap Belt Only installation continued on page 64.*

REAR-FACING SETUP

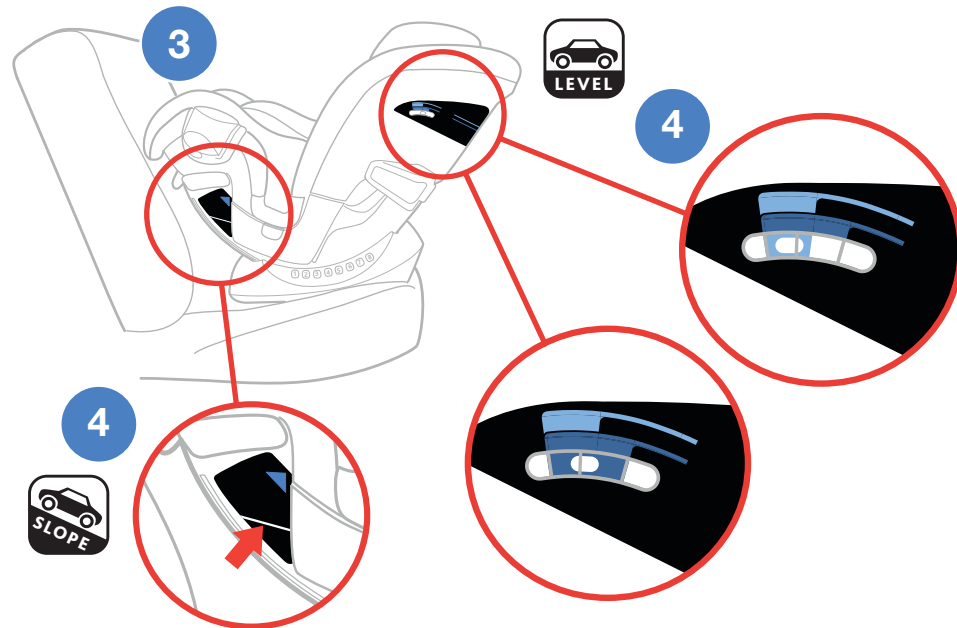

INSTALL USING LATCH

⚠ Do not use the lower anchors of the Child Restraint anchorage system (LATCH system) to attach this Child Restraint when restraining a child weighing more than **35 lbs (15.9 kg)** with the internal harness of the Child Restraint.

⚠ When installing with LATCH in a vehicle equipped with inflatable seat belts, the unused seat belt should **NOT** be buckled behind the Child Restraint System as this will engage the inflatable portion of the belt.

- 1 Locate the LATCH Connector Storage compartments. Remove LATCH straps. Make sure SuperCinch® LATCH Tightener strap (Pull 2nd) and LATCH Adjuster strap (Pull 1st) are loosened to their full length.

INSTALL USING LATCH

Make sure LATCH Adjuster strap (Pull 1st) is loosened to the full length.

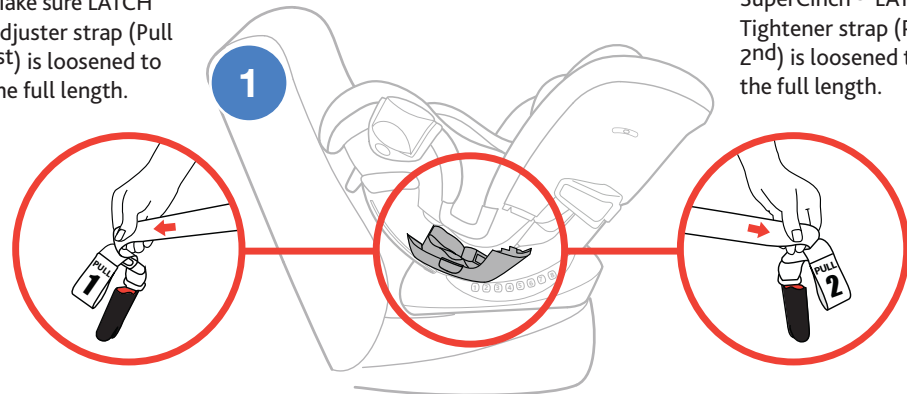

Make sure SuperCinch® LATCH Tightener strap (Pull 2nd) is loosened to the full length.

INSTALL USING LATCH

- 2 Grab both ends of LATCH straps. Slide LATCH strap to blue **REAR-FACING** opening on both sides. Note: Both LATCH Connector Storage compartments must be open and both LATCH straps must be loosened to their full length in order to slide LATCH straps into position.
- 3 Close both LATCH Connector Storage compartments.

⚠ When not accessing the LATCH or changing the belt path **ALWAYS** keep LATCH Connector Storage compartments closed.

INSTALL USING LATCH

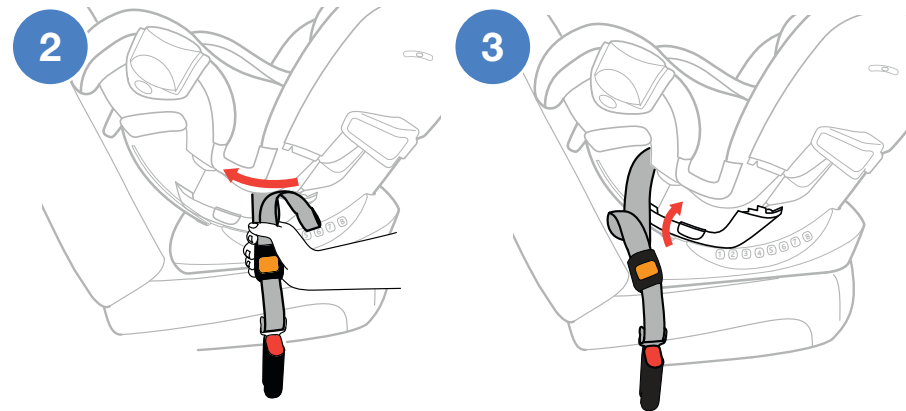

INSTALL USING LATCH

- 4 Locate the LATCH anchor bars in your vehicle. Attach both LATCH Connectors to the vehicle LATCH bars.
- 5 Pull up on the end of the LATCH Adjuster strap (Pull 1st) until strap is tight.
- 6 Pull on the SuperCinch® LATCH Tightener strap (Pull 2nd) to secure the Child Restraint.

CHECK YOUR WORK

- ✓ Hold Child Restraint at each side near REAR-FACING vehicle belt paths. Pull side to side and forward. Child Restraint should not move more than 1" (25 mm) from vehicle seat back or side-to-side.
- ✓ Make sure Child Restraint is level for REAR-FACING use. Make sure infant's head does not fall forward. If necessary, loosen the Latch Strap, re-adjust recline and repeat installation steps to make sure Child Restraint is installed properly.
- ✓ Check installation before every use!

INSTALL USING LATCH

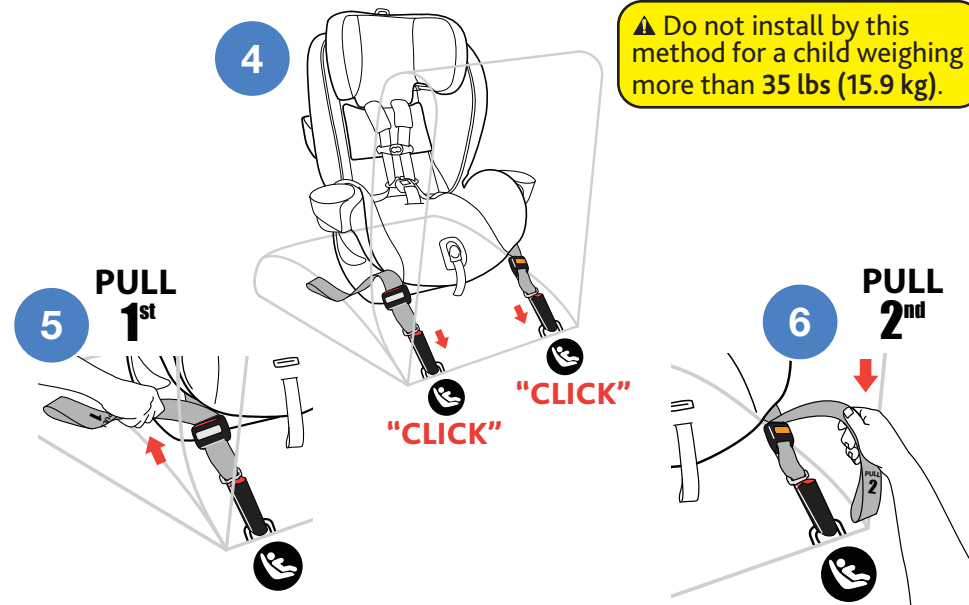

INSTALL USING LAP-SHOULDER BELT

- Route vehicle lap-shoulder belt through the blue **REAR-FACING** seat belt path on the side of Child Restraint (a). Locate the opening in the seat pad (b). With your right hand guide the vehicle lap-shoulder belt UNDER the seat pad.
- With your other hand in the opposite opening, pass off the vehicle lap-shoulder belt from your right hand to your left hand.
Vehicle belt must be routed behind the Crotch Strap when the Crotch Strap is in the forward position (closest to the Harness Release Button) or in front of the Crotch Strap when it is in the rear position. Thread the vehicle belt down and out through the blue **REAR-FACING** seat belt path on opposite side of Child Restraint.
- Buckle the vehicle belt.

INSTALL USING LAP-SHOULDER BELT

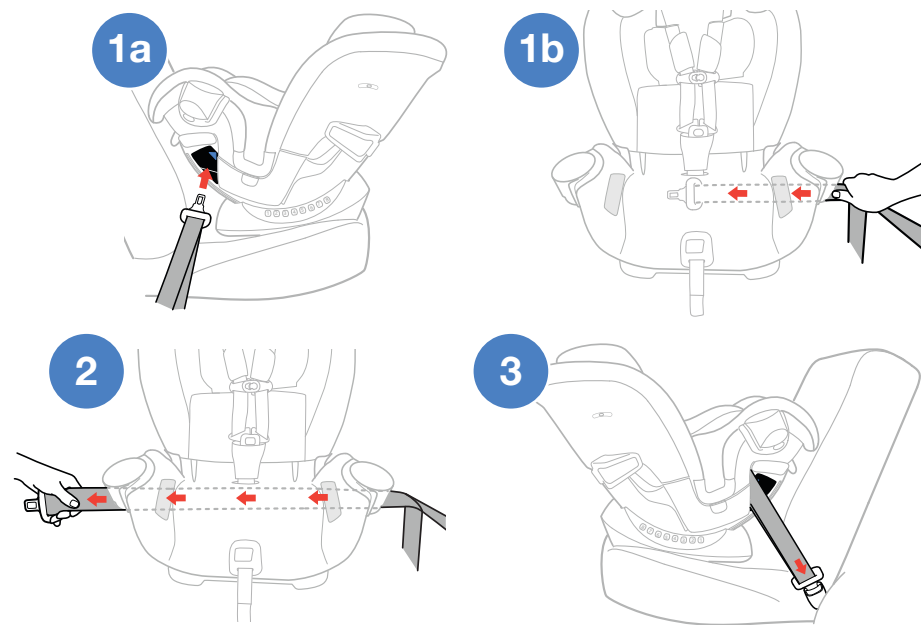

INSTALL USING LAP-SHOULDER BELT

- 4 While pushing down on the Child Restraint (a) pull the vehicle shoulder belt (b) to tighten vehicle lap belt.
- 5 While still pulling the shoulder belt tight, slide the vehicle shoulder belt into the Lock-Off. Always use the Lock-Off on the opposite side of the vehicle belt buckle.

CHECK YOUR WORK

- ✓ Hold Child Restraint at each side near REAR-FACING vehicle belt paths. Pull side to side and forward. Vehicle belt should remain tight and Child Restraint should not move more than 1" (25 mm) from vehicle seat back or side-to-side.
- ✓ Make sure Child Restraint is level for REAR-FACING use. Make sure infant's head does not fall forward. If necessary, loosen the vehicle belt, re-adjust recline and repeat installation steps to make sure Child Restraint is installed properly.
- ✓ Check installation before every use!

INSTALL USING LAP-SHOULDER BELT

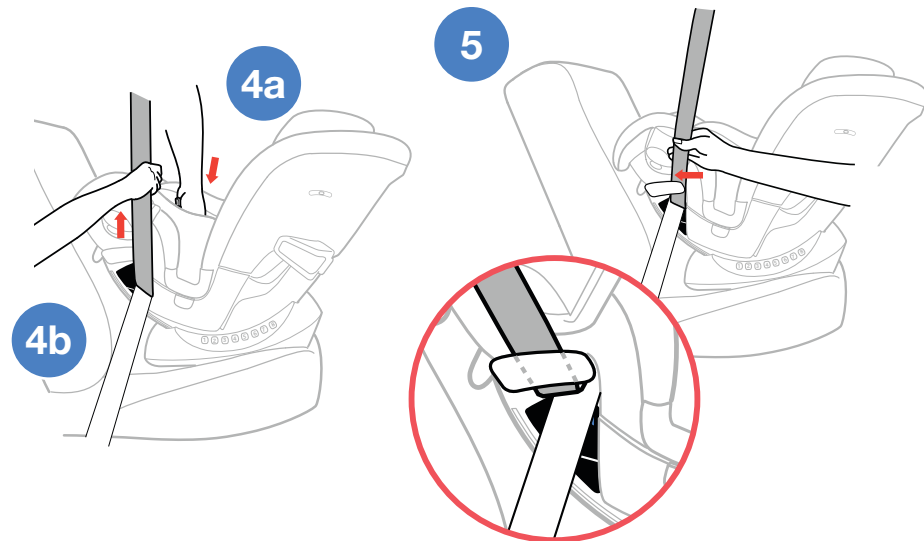

INSTALL USING LAP BELT ONLY

- 1 Route vehicle lap belt through the blue **REAR-FACING** seat belt path on the side of Child Restraint (a). Locate the opening in the seat pad (b). With your right hand guide the vehicle lap belt UNDER the seat pad.
- 2 With your other hand in the opposite opening, pass off the vehicle lap belt from your right hand to your left hand.
Vehicle belt must be routed behind the Crotch Strap when the Crotch Strap is in the forward position (closest to the Harness Release Button) or in front of the Crotch Strap when it is in the rear position.
 Thread the vehicle belt down and out through the blue **REAR-FACING** seat belt path on opposite side of Child Restraint.
- 3 Buckle the vehicle belt.

INSTALL USING LAP BELT ONLY

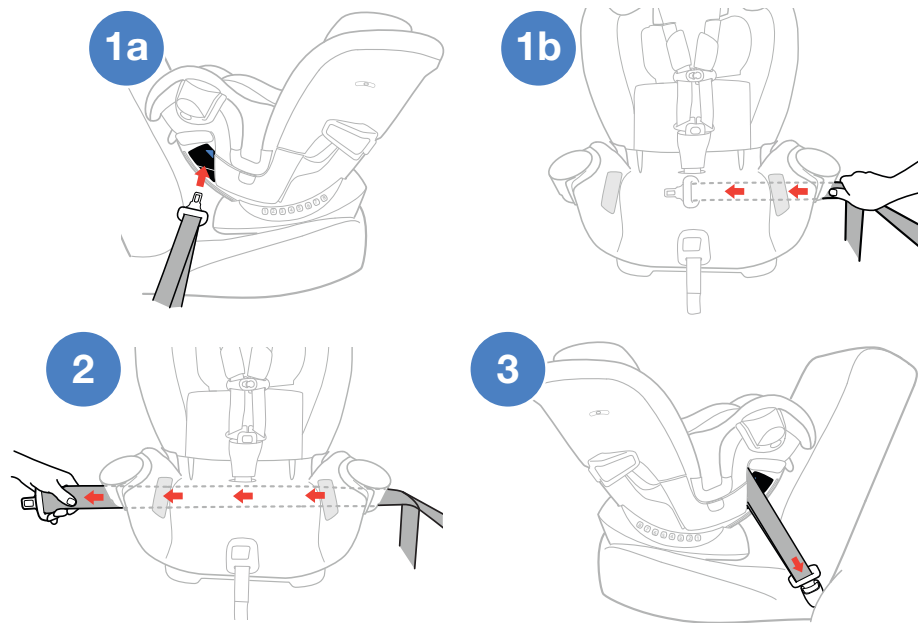

INSTALL USING LAP BELT ONLY

- 4 While pushing down on the Child Restraint (a) pull the loose end of the vehicle lap belt (b) to tighten belt.

CHECK YOUR WORK

- ✓ Hold Child Restraint at each side near REAR-FACING vehicle belt paths. Pull side to side and forward. Vehicle belt should remain tight and Child Restraint should not move more than 1" (25 mm) from vehicle seat back or side-to-side.
- ✓ Make sure Child Restraint is level for REAR-FACING use. Make sure infant's head does not fall forward. If necessary, loosen the vehicle belt, re-adjust recline and repeat installation steps to make sure Child Restraint is installed properly.
- ✓ Check installation before every use!

INSTALL USING LAP BELT ONLY

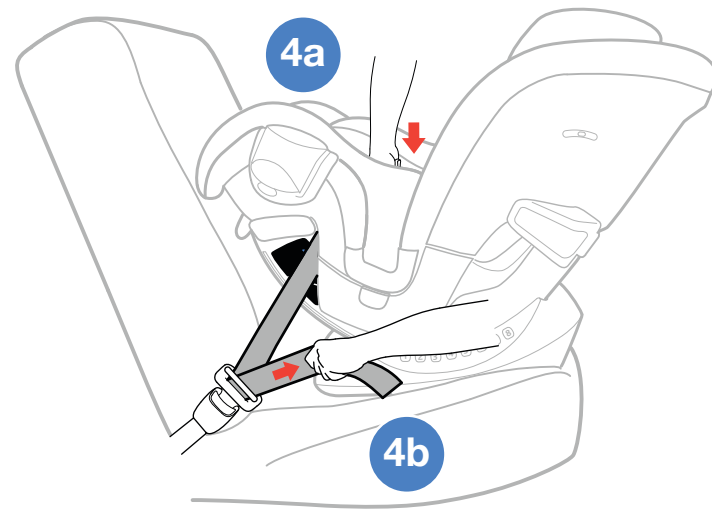

FORWARD-FACING SETUP

- 1** Before placing the Child Restraint in the vehicle, remove Tether from the Tether compartment. You may need to squeeze the Tether Button and pull down to loosen the strap before removing. If a tether anchor is not available, the Tether should be stored properly.
- 2** See page 40 for “Vehicle Seating Positions” before installing. Make sure the vehicle is on a level surface, if possible.



- 3** Squeeze the Recline Adjustment Handle on front of Child Restraint and push back to adjust to an upright position as shown (a).

If a change in recline position is necessary, after Child Restraint is installed, loosen the current method of installation and adjust the recline. Repeat installation steps and refer to pages 69-97 to ensure Child Restraint is installed correctly.

FORWARD-FACING SETUP

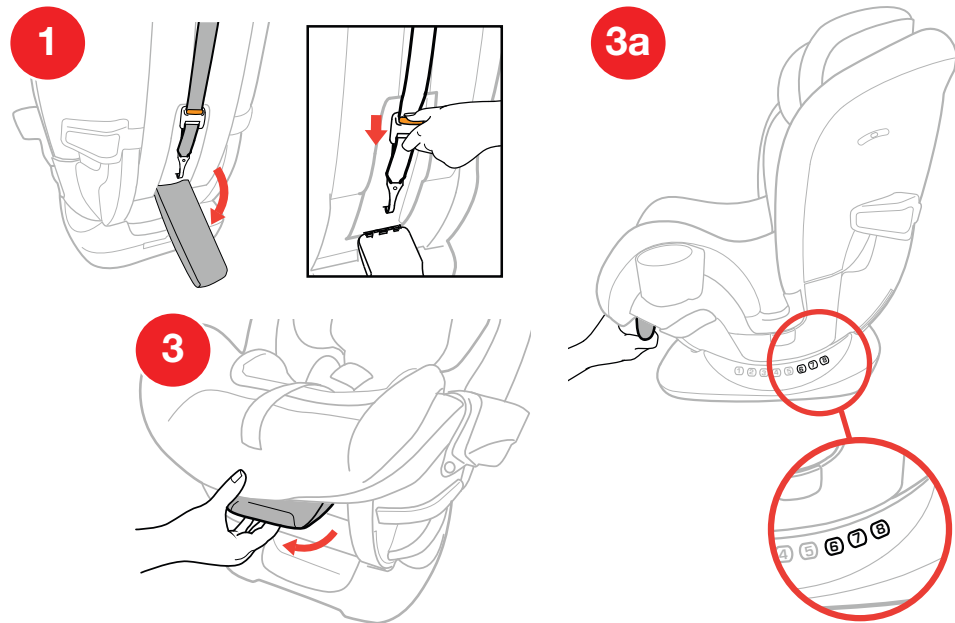

FORWARD-FACING SETUP

4 Place Child Restraint facing forward on selected vehicle seat. Make sure it is not blocking the vehicle belt buckle. Lay Tether Strap over the back of the vehicle seat. Push the Child Restraint back until it touches the vehicle seat back and make sure the base stays flat on the vehicle seat.

5  **Installation on a Level Surface:** Locate the Bubble Level Indicator label and re-adjust the seat recline to any position that the Bubble falls between the **Harness** lines.

 **Installation on a Slope:** If vehicle is on a slope adjust the seat recline to position 7 or 8 **ONLY**.

Installation Options:

- *LATCH installation continued on page 72.*
- *Lap-Shoulder Belt installation continued on page 78.*
- *Lap Belt Only installation continued on page 90.*

FORWARD-FACING SETUP

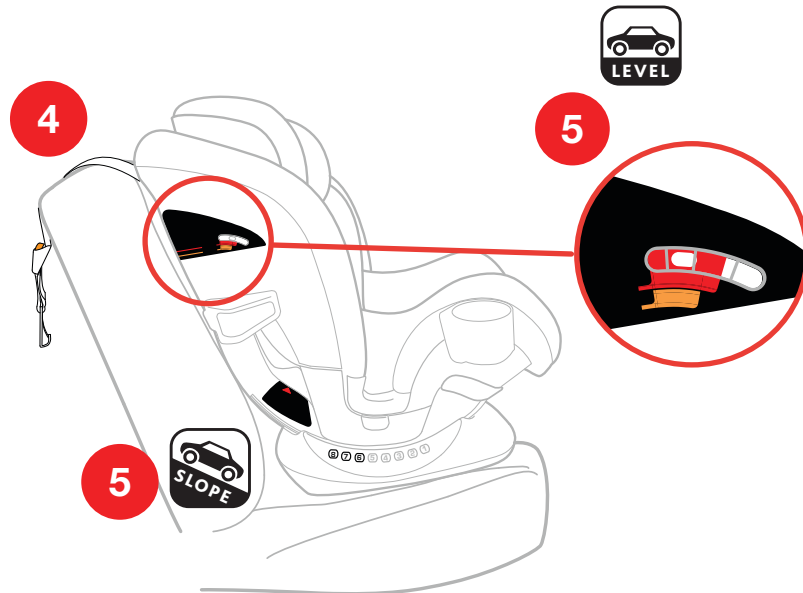

INSTALL USING LATCH

⚠ Do not use the lower anchors of the Child Restraint anchorage system (LATCH system) to attach this Child Restraint when restraining a child weighing more than **40 lbs (18 kg)** with the internal harness of the Child Restraint.

⚠ When installing with LATCH in vehicle equipped with inflatable seat belts, the unused seat belt should NOT be buckled behind the Child Restraint System as this will engage the inflatable portion of the belt.

- 1 Locate LATCH Connector Storage compartments. Remove LATCH straps. Make sure SuperCinch® LATCH Tightener strap (Pull 2nd) and LATCH Adjuster strap (Pull 1st) are loosened to their full length.
- 2 Grab both ends of LATCH straps. Slide LATCH strap to red **FORWARD-FACING** opening on both sides. Note: Both LATCH Connector Storage compartments must be open and both LATCH straps must be loosened to their full length in order to slide LATCH straps into position.
- 3 Close both LATCH Connector Storage compartments.

INSTALL USING LATCH

Make sure SuperCinch® LATCH Tightener strap (Pull 2nd) is loosened to the full length.

1

Make sure LATCH Adjuster strap (Pull 1st) is loosened to the full length.

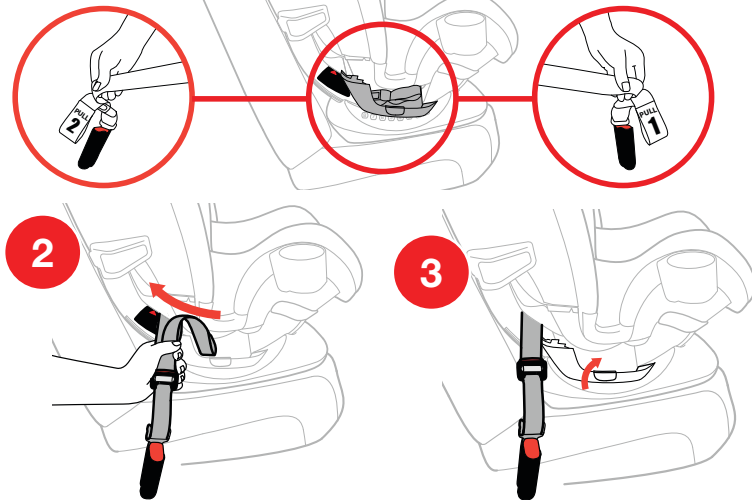

INSTALL USING LATCH

⚠ When not accessing the LATCH or changing the belt path **ALWAYS** keep LATCH Connector Storage compartments closed.

- 4 Locate the LATCH bars in your vehicle. Attach both LATCH Connectors to the vehicle LATCH anchor bars.
- 5 Pull up on the end of the LATCH Adjuster strap (Pull 1st) until strap is tight.
- 6 Pull on the SuperCinch® LATCH Tightener strap (Pull 2nd) to secure Child Restraint.

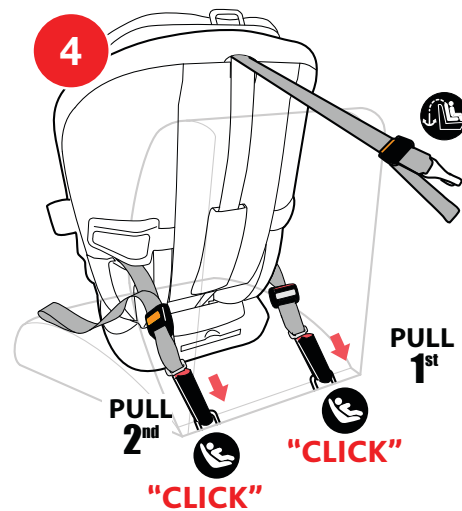

⚠ Do not install by this method for a child weighing more than 40 lbs (18 kg).

INSTALL USING LATCH

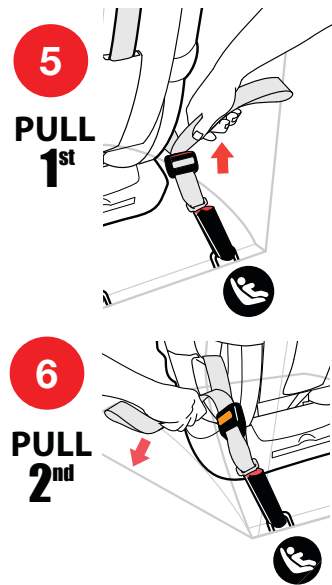

INSTALL USING LATCH

- 7 Locate Tether Anchor in your vehicle. Attach Tether Hook. Pull Tether Adjuster strap to tighten.

CHECK YOUR WORK

- ✓ Hold Child Restraint at each side near FORWARD-FACING vehicle belt path. Pull side to side and forward. Child Restraint should not move more than 1" (25 mm) from vehicle seat back or side-to-side.
- ✓ Make sure Bubble is between lines on label for FORWARD-FACING use. If necessary, loosen the LATCH and Tether Straps, re-adjust recline and repeat installation steps to make sure Child Restraint is installed properly.
- ✓ Check installation before every use!

INSTALL USING LATCH

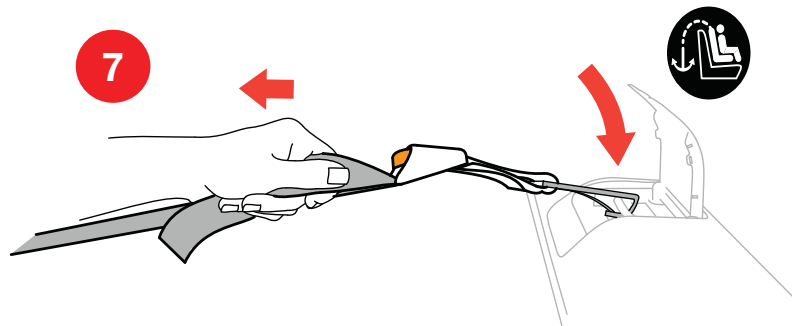

INSTALL USING LAP-SHOULDER BELT

Lap-Shoulder Belt with Tether Strap is the Recommended Installation Method

- 1** With the Base adjusted to the correct recline and install position. Loosen the harness straps and undo the buckle.
- 2** Raise the headrest to the highest position (a) and lift the headrest fabric up and out of the way (b).
- 3** Unsnap the seat pad fabric and pull the seat pad fabric forward and out of the way.

⚠ When installing the seat forward-facing with the vehicle's lap or lap and shoulder belt system, always make sure the vehicle belt is routed and secured with the LeverLock® mechanism.

INSTALL USING LAP-SHOULDER BELT

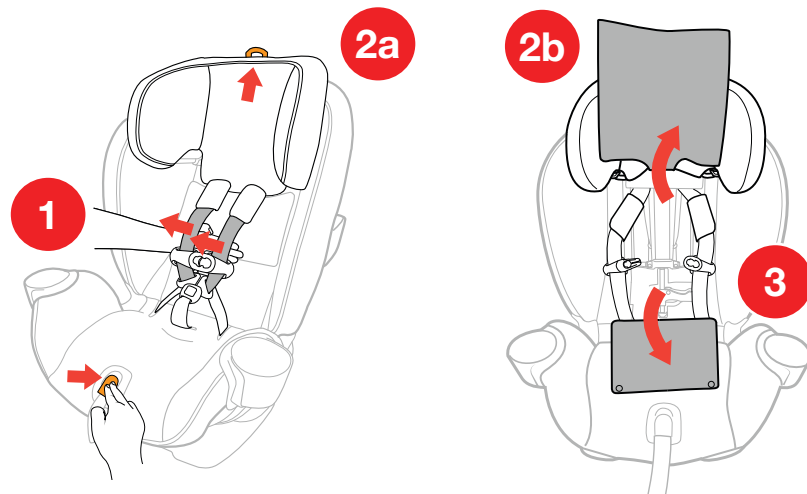

INSTALL USING LAP-SHOULDER BELT

Lap-Shoulder Belt with Tether Strap is the Recommended Installation Method

- 4 Locate the LeverLock® Release Handle in the seat back. Squeeze the LeverLock® Release Handle, and rotate the handle all the way to the left.
- 5 Pull out the Vehicle Lap-Shoulder Belt. Then route the straps up through the **FORWARD-FACING** belt path opening (a).

INSTALL USING LAP-SHOULDER BELT

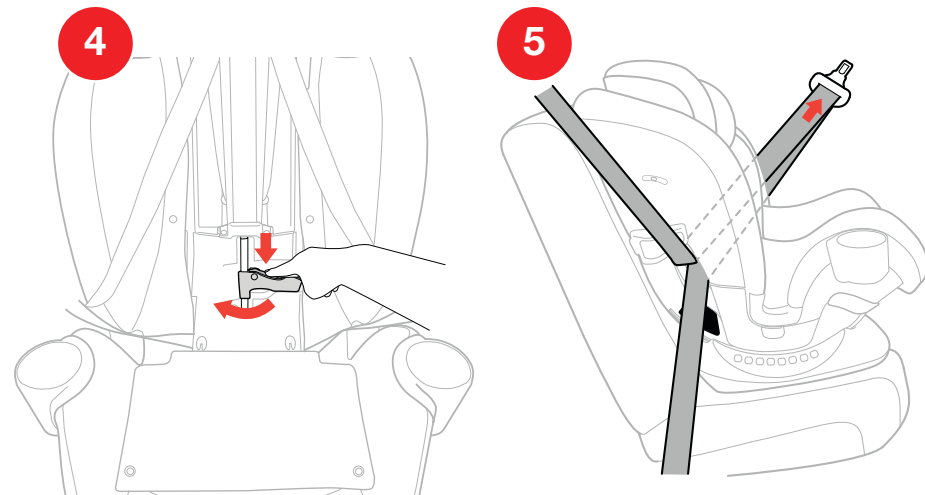

INSTALL USING LAP-SHOULDER BELT

Lap-Shoulder Belt with Tether Strap is the Recommended Installation Method

- 6** Pass the vehicle belt along the back of the Child Restraint. Pull the straps down through the red **FORWARD-FACING** seat belt path on the opposite side of Child Restraint.
- 7** Buckle the Vehicle Lap-Shoulder Belt. Pull any slack out of the lap and shoulder belt.
- 8** In the middle of the seat back grasp both the Lap and Shoulder Belt straps. Pull the straps down and guide them up between the LeverLock® Tension Bars. Make sure all of the slack is removed from the Lap-Shoulder Belt.

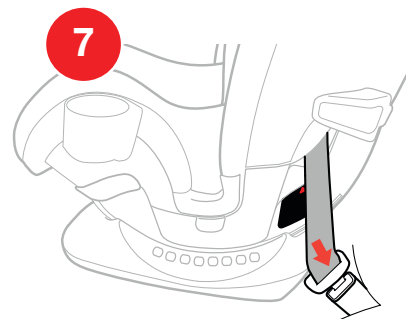
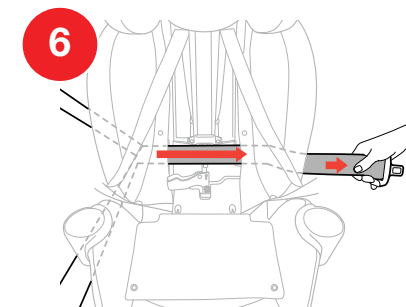

INSTALL USING LAP-SHOULDER BELT

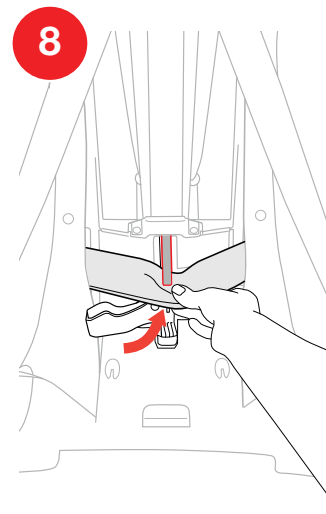

INSTALL USING LAP-SHOULDER BELT

Lap-Shoulder Belt with Tether Strap is the Recommended Installation Method

- 9 Push up on the LeverLock® Handle (a) and rotate the Handle to the right (b) and press "IN" on the handle until you hear a click indicating the LeverLock® Handle is Locked (c).

CHECK YOUR WORK

- ✓ Hold Base at each side near vehicle belt paths. Pull side to side and forward. Vehicle belt should remain tight and Base should not move more than 1" (25 mm) from vehicle seat back or side-to-side.
- ✓ Make sure Child Restraint is level for FORWARD-FACING use. If necessary, open LeverLock® Handle, undo the vehicle belt, re-adjust recline and repeat installation steps to make sure Child Restraint is installed properly.
- ✓ Check installation before every use!

INSTALL USING LAP-SHOULDER BELT

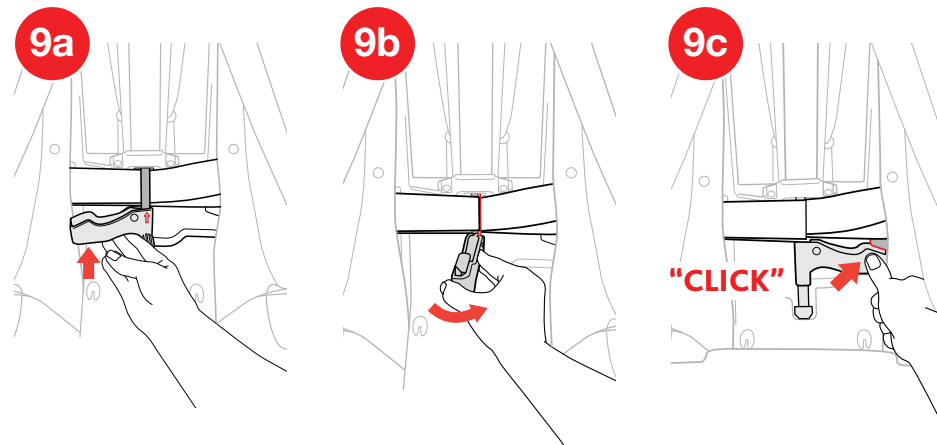

INSTALL USING LAP-SHOULDER BELT

- 10 Replace the seat pad, headrest pad, and Harness straps back into correct position.
- 11 While pulling the shoulder belt tight (a), slide the vehicle shoulder belt into the Shoulder Belt Guide (b). Always use the Shoulder Belt Guide on the opposite side of the vehicle belt buckle.

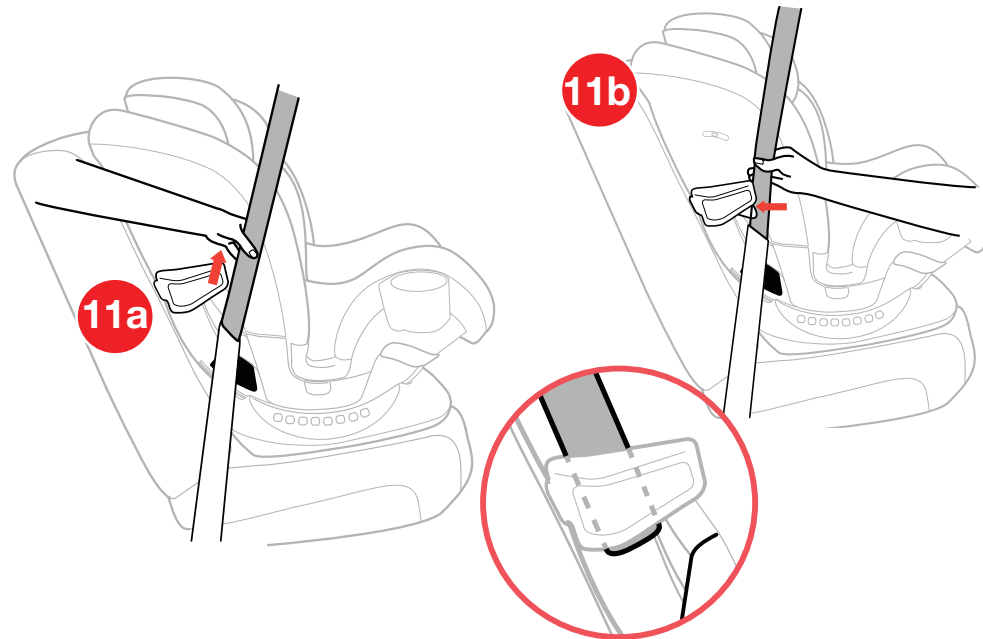

INSTALL USING LAP-SHOULDER BELT

INSTALL USING LAP-SHOULDER BELT

- 12** Locate Tether anchor in your vehicle. Attach Tether Hook. Pull Tether Adjuster strap to tighten.

CHECK YOUR WORK

- ✓ Hold Base at each side near vehicle belt paths. Pull side to side and forward. Vehicle belt should remain tight and Base should not move more than 1" (25 mm) from vehicle seat back or side-to-side.
- ✓ Make sure Child Restraint is level for FORWARD-FACING use. If necessary, open LeverLock® Handle, undo the vehicle belt, re-adjust recline and repeat installation steps to make sure Child Restraint is installed properly.
- ✓ Check installation before every use!

INSTALL USING LAP-SHOULDER BELT

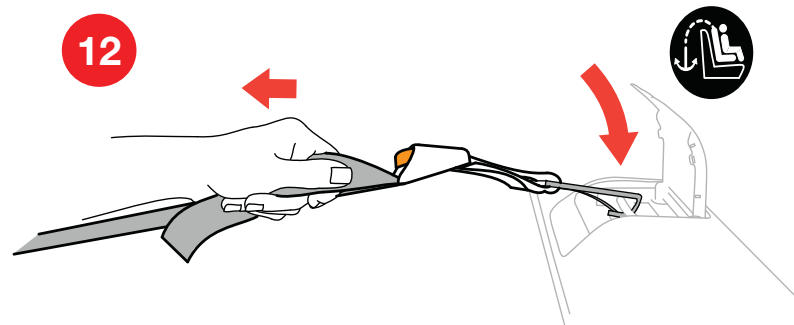

INSTALL USING LAP BELT

With the Base adjusted to the correct recline and install position. Loosen the harness straps and undo the buckle. Raise the headrest to the highest position and lift the headrest fabric up and out of the way. Unsnap the seat pad fabric and pull the seat pad fabric forward and out of the way. See pages 78 and 79.

- 1 Locate the LeverLock® Release Handle in the seat back. Squeeze the LeverLock® Release Handle, and rotate the handle all the way to the left.
- 2 Pull out the Vehicle Lap Belt. Then route the straps up through the **FORWARD-FACING** belt path opening (a). Pass the vehicle belt along the back of the Child Restraint (b). Pull the strap down through the red **FORWARD-FACING** seat belt path on the opposite side of Child Restraint.

INSTALL USING LAP BELT

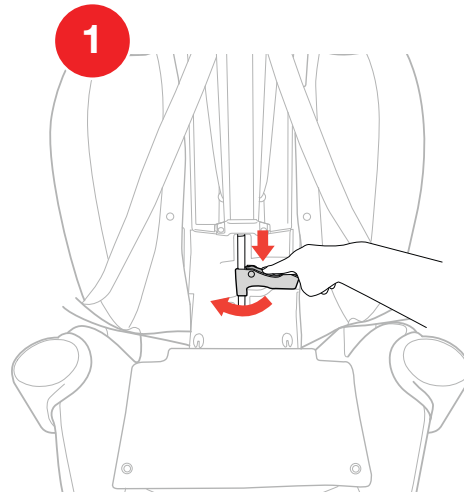

INSTALL USING LAP BELT

- 3 Pass the vehicle belt along the back of the Child Restraint. Pull the straps down through the red **FORWARD-FACING** seat belt path on the opposite side of Child Restraint.
- 4 Buckle the Vehicle Lap Belt. Pull any slack out of the lap belt.
- 5 In the middle of the seat back grasp the Lap Belt strap. Pull the strap down and guide them up between the LeverLock® Tension Bars. Make sure all of the slack is removed from the Lap Belt strap.

⚠ When installing the seat forward-facing with the vehicle's lap or lap and shoulder belt system, always make sure the vehicle belt is routed and secured with the LeverLock® mechanism.

INSTALL USING LAP BELT

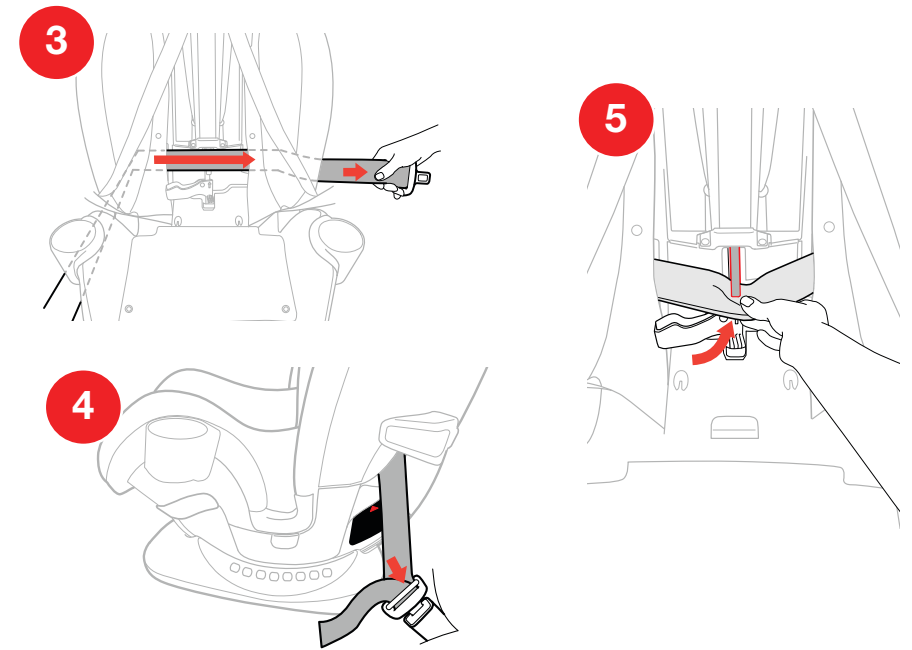

INSTALL USING LAP BELT

Lap-Shoulder Belt with Tether Strap is the Recommended Installation Method

- 6 Push up on the LeverLock® Handle (a) and rotate the Handle to the right (b) and press "IN" on the handle until you hear a click indicating the LeverLock® Handle is Locked (c).

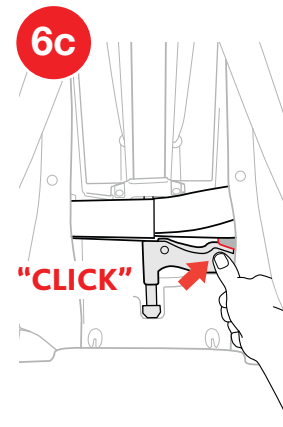
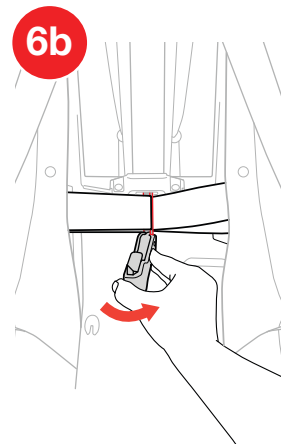
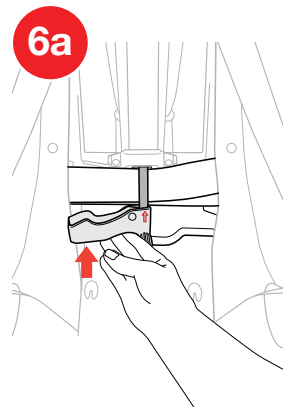

INSTALL USING LAP BELT

INSTALL USING LAP BELT ONLY

- 7 While pushing down on the Child Restraint (a) pull the loose end of the vehicle lap belt (b) to tighten.
- 8 Locate Tether Anchor in your vehicle. Attach Tether Hook. Pull Tether Adjuster strap to tighten.

CHECK YOUR WORK

- ✓ Hold Base at each side near vehicle belt paths. Pull side to side and forward. Vehicle belt should remain tight and Base should not move more than 1" (25 mm) from vehicle seat back or side-to-side.
- ✓ Make sure Child Restraint is level for FORWARD-FACING use. If necessary, open LeverLock® Handle, undo the vehicle belt, re-adjust recline and repeat installation steps to make sure Child Restraint is installed properly.
- ✓ Check installation before every use!

INSTALL USING LAP BELT ONLY

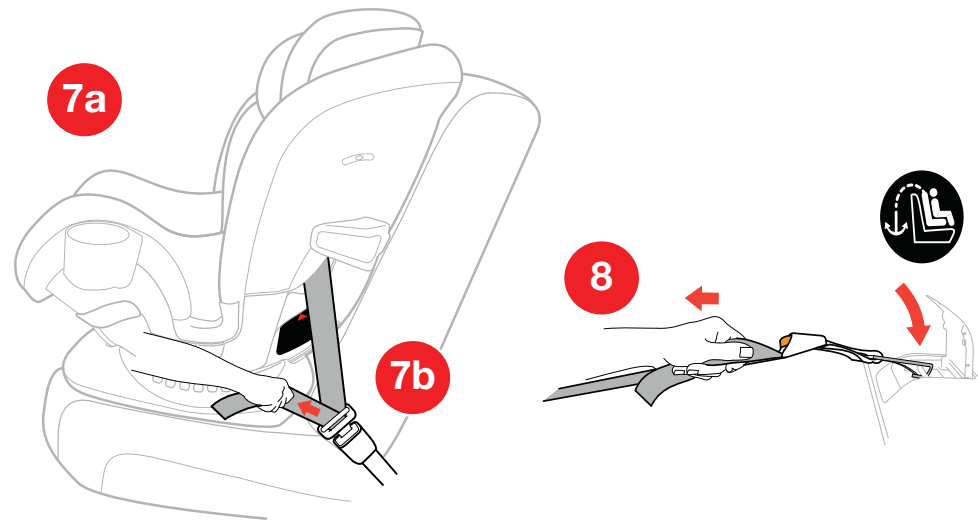

SECURING CHILD WITH HARNESS

For a better fit in the Child Restraint with smaller infants, the Newborn Positioner provided must be used. See page 38-39 for more details. Additionally, crotch strap pad and shoulder pads may need to be removed.

If Crotch Strap is under child, the crotch strap will need to be re-positioned, refer to page 34 "Adjusting Crotch Strap". When moving the child restraint from rear-facing mode to forward-facing harness mode, the crotch strap must be adjusted to the front position.

- 1 Loosen Harness by pressing Harness Release Button (under the fabric) on the front of the Child Restraint and pulling forward on both of the Harness Straps.
- 2 Unbuckle Harness by pressing the button on Harness Buckle and pulling out both Buckle Tongues.
- 3 Open Chest Clip by squeezing the button in the middle of the clip and pulling apart.

SECURING CHILD WITH HARNESS

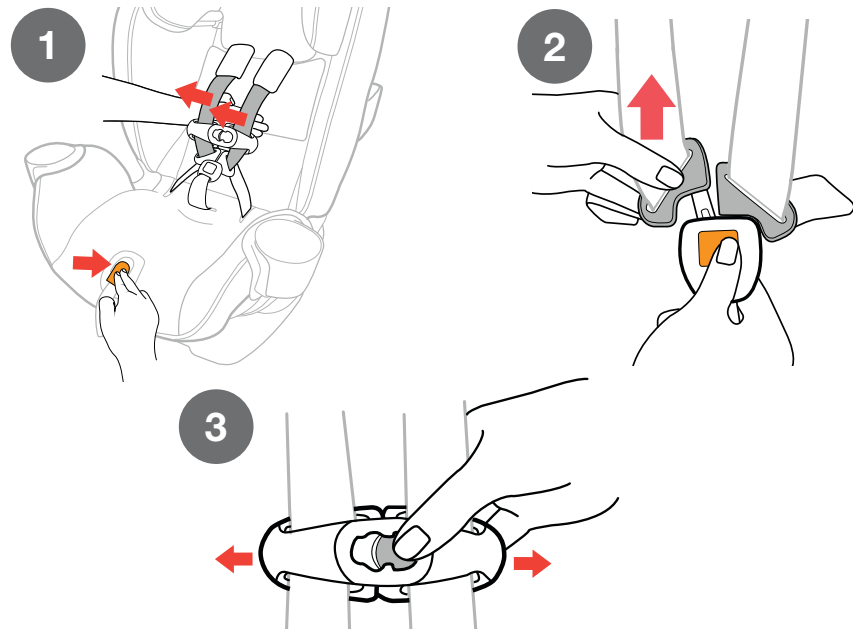

SECURING CHILD WITH HARNESS

- 4 Place child in Child Restraint with child's back flat against the back of the seat. Pull Harness Straps over the child's shoulders and around the child's waist. Make sure there are no twists in Harness Strap.

Clothing, such as bulky winter coats that interfere with the proper placement or adjustment of the Harness system should never be used. Make sure the Harness Straps lie flat on the child's shoulders, are adjusted snugly so that clothing is compressed and the child cannot lean forward, and the Chest Clip is at arm level.

SECURING CHILD WITH HARNESS

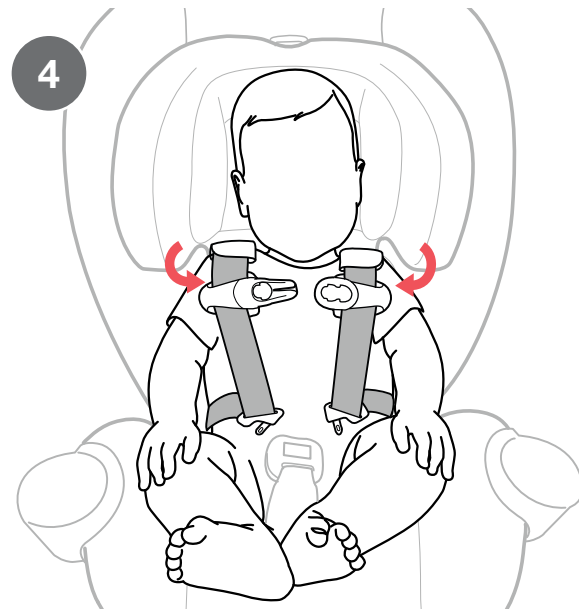

SECURING CHILD WITH HARNESS

- 5 Adjust Harness Strap height position up or down by pulling up on the Headrest Adjustment Tab on the top of the Child Restraint Headrest. Make sure Head Rest locks into position before tightening Harness.

REAR-FACING POSITION - Position the Harness Straps at or below the child's shoulders.

FORWARD-FACING POSITION - Position the Harness Straps at or above the child's shoulders.

If using Head Rest/Harness in lowest position, DO NOT fold Seat Back Panel.

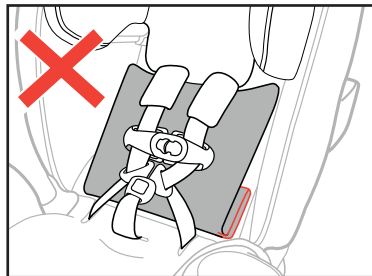
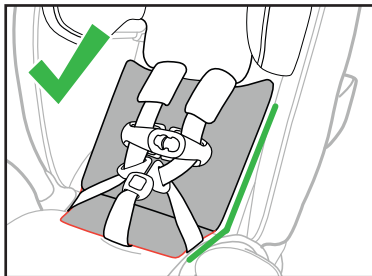

SECURING CHILD WITH HARNESS

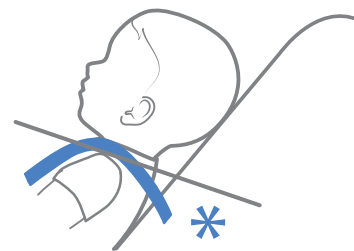
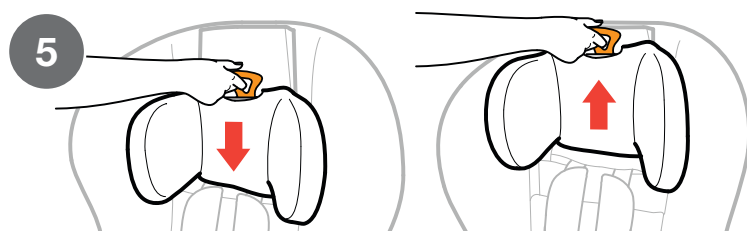

**REAR-FACING
AT OR BELOW**

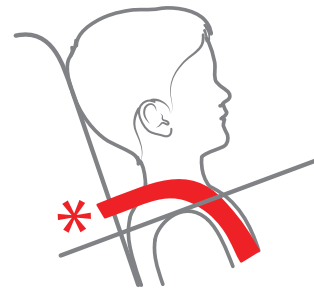

**FORWARD-FACING
AT OR ABOVE**

- 6 Insert each Buckle Tongue into Harness Buckle; listen for a click (a). Pull up firmly on both Buckle Tongues to make sure that they are securely latched (b).

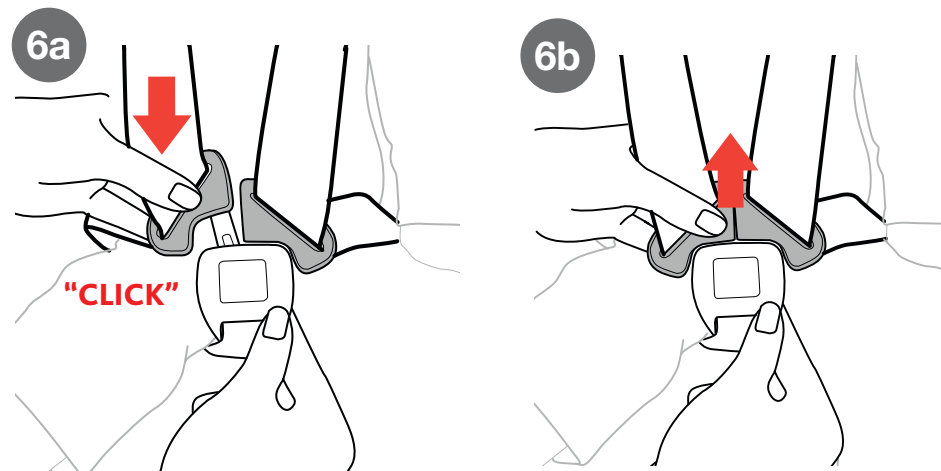

SECURING CHILD WITH HARNESS

- 7 Fasten Chest Clip by snapping both sides together; listen for a click.

Harness straps must fit snugly and lay flat on the center of your child's shoulders.

- 8 Push Chest Clip and Shoulder Pads down away from the child's neck and towards the Harness Buckle. Pull up on both shoulder straps to remove all slack from below.

SECURING CHILD WITH HARNESS

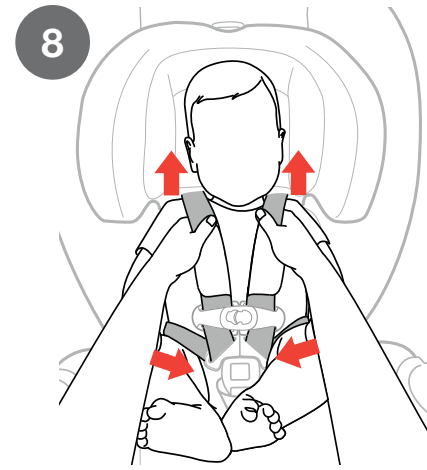

SECURING CHILD WITH HARNESS

- 9** Tighten the harness by pulling slowly on Harness Adjustment Strap until the harness is snug on child (a). If you can pinch a fold in the strap at the child's shoulders, harness is too loose (b). If the harness is too loose pull the Harness Adjustment strap more.
- 10** Move the Shoulder Pads up to the child's shoulders. Slide Chest Clip up to center of child's chest, level with the armpits.

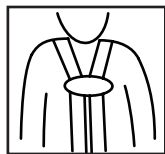

⚠ WARNING - If harness is not snug around your child, child could be ejected in a sudden stop or crash resulting in serious injury or death.

SECURING CHILD WITH HARNESS

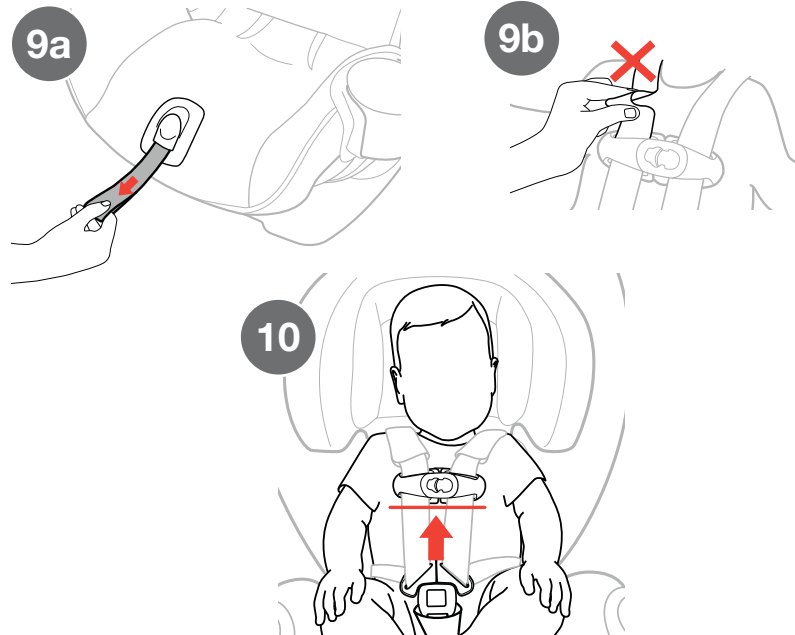

SECURING CHILD CHECKLIST

- ✓ Harness Straps must be snug. If you can pinch a fold in the strap, the harness is too loose. A snug strap should not allow any slack. It lies in a relatively straight line without sagging. It does not press on the child's flesh or push the child's body into an unnatural position.



- ✓ To ensure a better fit for smaller infants, the Headrest Insert and Newborn Positioner must be used. Never place extra padding under or behind the child. Only use the Newborn Positioner.
- ✓ Straps must lay flat, free of twists and centered on top of the child's shoulders.
- ✓ Check the height of the Harness Straps: Position the Harness Straps at or below the child's shoulders for REAR-FACING and at or above the child's shoulders for FORWARD-FACING.



REAR-FACING

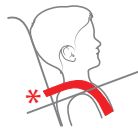

FORWARD-FACING

SECURING CHILD CHECKLIST

- ✓ Check the position of Chest Clip: Chest Clip should be centered on the child's chest, level with the armpits.
- ✓ Never secure child in Child Restraint with child dressed in bulky garments or heavy clothing. Heavy clothing can prevent harness from being properly tightened around child.
- ✓ Never secure child in Child Restraint with child wrapped in a blanket. To keep child warm, place a blanket over child AFTER you have properly secured and tightened harness around child.

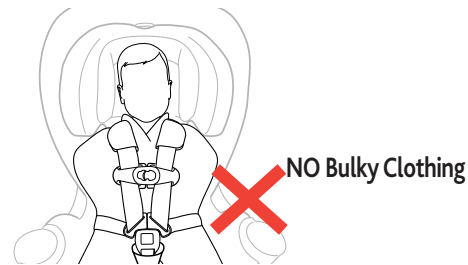

⚠ WARNING - If harness is not snug around your child, child could be ejected in a sudden stop or crash resulting in serious injury or death.

BOOSTER MODE SETUP

Store the Harness Straps and Crotch Strap properly when using the Child Restraint in BOOSTER MODE.

- 1 Remove the Newborn Positioner. Completely loosen Harness by pressing Harness Release Button on the front of the Child Restraint and pulling out on both of the Harness Straps as far as possible. Then unbuckle the Chest Clip and Harness Buckle.
- 2 Lift the top backrest padding on the back of the seat.

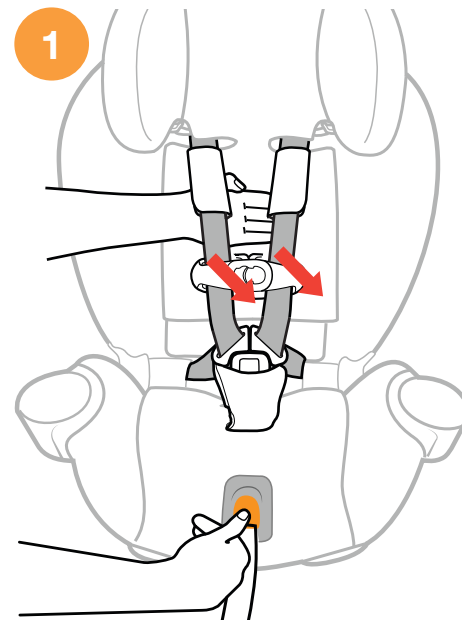

BOOSTER MODE SETUP

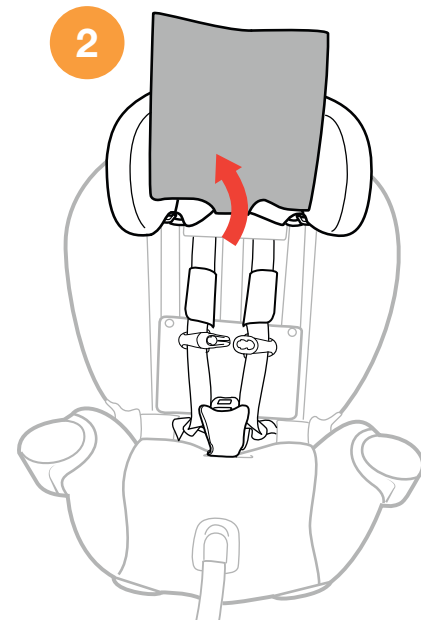

BOOSTER MODE SETUP

- 3 Undo both snap buttons on the lower Backrest Seat Pad and pull forward. Remove the Shoulder Pads and Crotch Strap Pad; store for later use. Refer to pages 138 and 139.
- 4 Insert the chest clip and buckle tongue into the corresponding compartment on either side of the Seat Back. Make sure the Harness Straps lay flat against the seat back.

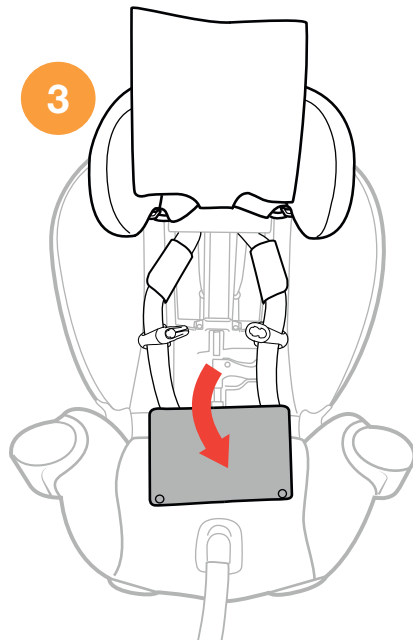

BOOSTER MODE SETUP

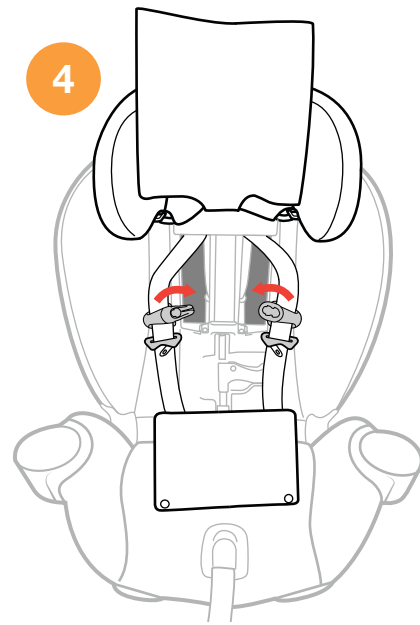

BOOSTER MODE SETUP

- 5 Remove the Crotch Strap from the slot and pull forward on the Seat pad to locate the Crotch Strap compartment below.
- 6 To store the Crotch Strap, fit the Crotch Strap buckle into the Crotch Strap compartment with the release button facing up. **(6a)**.

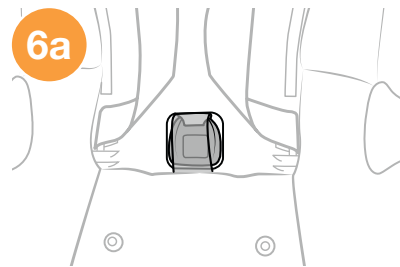
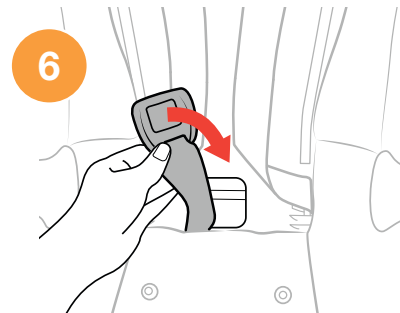
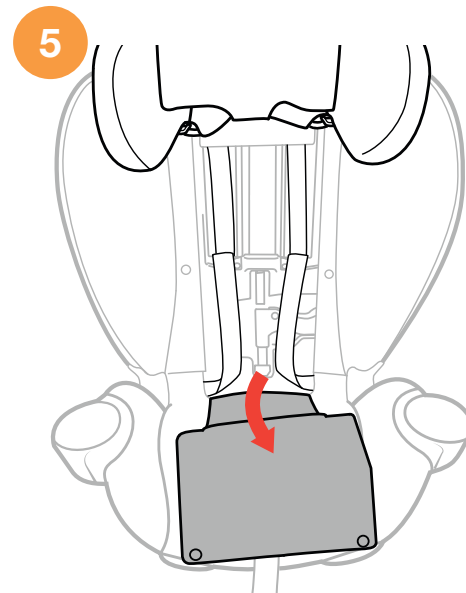

BOOSTER MODE SETUP

BOOSTER MODE SETUP

- 7 Repeat Booster Seat Setup Steps 2-3 (on pages 112-115) in REVERSE to re-attach the Backrest Seat Pads.

If using Higher Head Rest/Harness Position, make sure the seat back padding panel is folded down.

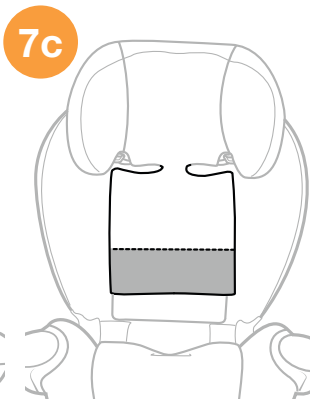
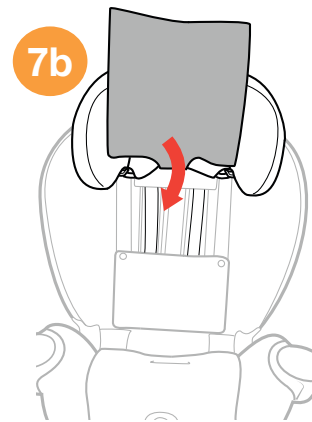
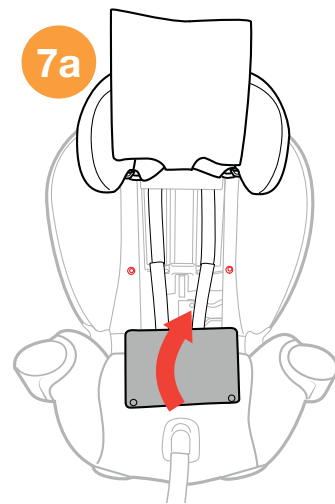

BOOSTER MODE SETUP

BOOSTER MODE INSTALLATION

- 1 See page 40 for “Vehicle Seating Positions” before installing. Make sure the vehicle is on a level surface, if possible.



- 2 Place the Booster Seat on the vehicle seat making sure the Seat Base is **PARALLEL** with the vehicle seating surface.
- 3 Check that the headrest of the vehicle seat does not interfere with the Headrest of the Booster Seat.

If the vehicle headrest pushes the Child Restraint forward, check your vehicle owner's manual to see if the headrest removal is permitted. If so, follow the vehicle owner's manual to remove the headrest. If it is not permitted, raise the vehicle headrest or move the Child Restraint to a different vehicle seating location.

BOOSTER MODE INSTALLATION

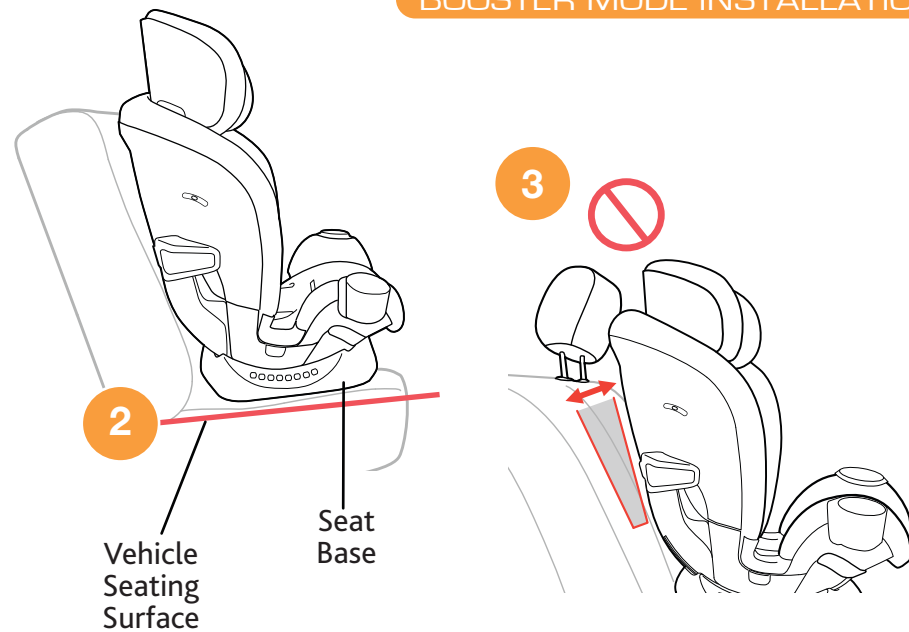

BOOSTER MODE INSTALLATION

- 4 Make sure the Child Restraint is not blocking the vehicle belt buckle.



Installation on a Level Surface: Locate the Bubble Level Indicator label and re-adjust the seat recline to any position that the Bubble falls between the **Booster** lines.



Installation on a Slope: If vehicle is on a slope, re-adjust the seat recline to position 7 or 8 only.

BOOSTER MODE INSTALLATION

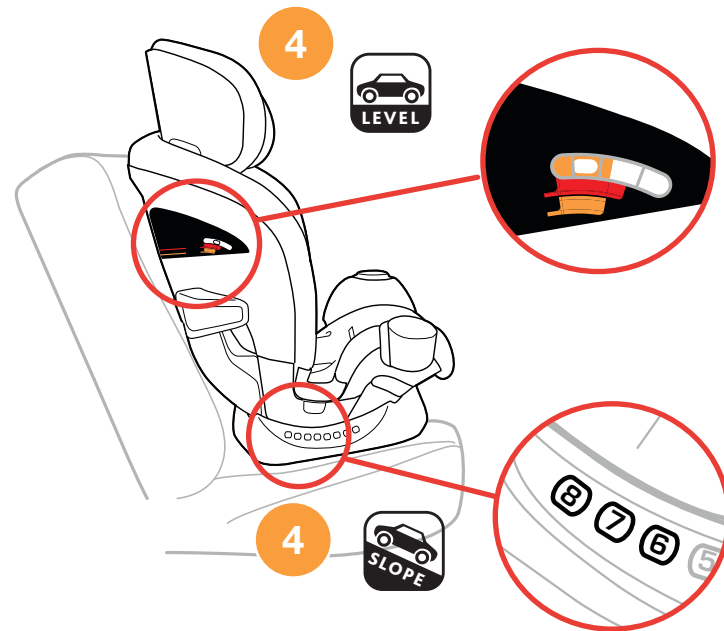

BOOSTER MODE INSTALLATION

Use of LATCH and Top Tether in BOOSTER MODE is completely optional. If LATCH and Tether is not used, make sure the LATCH and Tether Straps are properly stored. See page 17.

If using LATCH and Top Tether, locate the Tether compartment (see page 69) and LATCH Connector Storage compartment (see page 72) and remove the straps.

- 5 Locate the LATCH anchor bars in your vehicle. Attach both LATCH Connectors to the vehicle LATCH anchor bars.
- 6 Pull up on the end of the LATCH Adjuster strap (Pull 1st) until strap is tight.
- 7 Pull on the SuperCinch® LATCH Tightener strap (Pull 2nd) to secure Child Restraint.
- 8 Locate the Tether anchor in your vehicle. Attach Tether Hook. Pull Tether Adjuster strap to tighten.

If the seat is not secured with both the LATCH anchors and Top Tether, the seat must be secured with the vehicle Lap-Shoulder belt when not in use.

BOOSTER MODE INSTALLATION

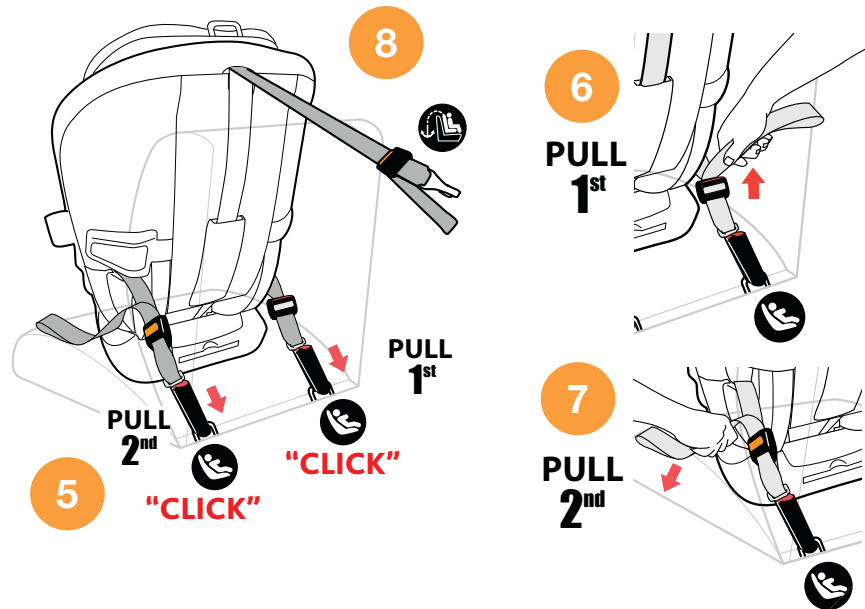

SECURING CHILD IN BOOSTER MODE

- 1 Place the child into the Child Restraint, making sure the child is sitting with his/her back against the Backrest.
- 2 The Shoulder Belt guide must be positioned at or just slightly above the child's shoulders. If not, adjust the Headrest to the proper height. See page 102 for adjusting the Headrest Height.

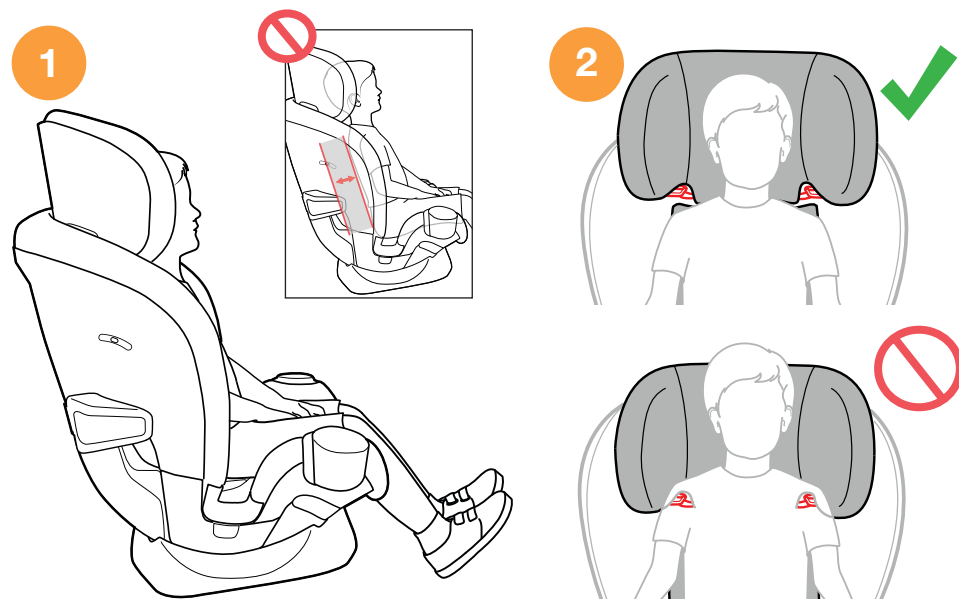

SECURING CHILD IN BOOSTER MODE

SECURING CHILD IN BOOSTER MODE

- 3 Route the lap shoulder belt across the child's thighs and chest, as shown.
- 4 Buckle the vehicle belt.



SECURING CHILD IN BOOSTER MODE

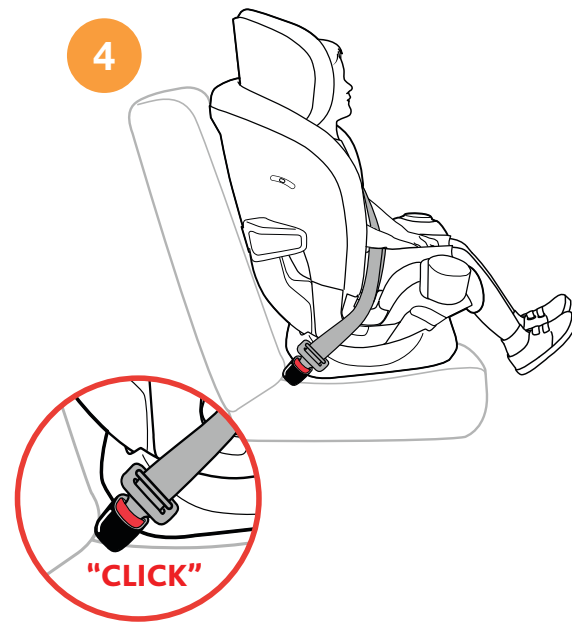

SECURING CHILD IN BOOSTER MODE

- 5 Slide the shoulder belt between the Headrest and the side of the Seat back (5a). Thread the shoulder belt through the orange Shoulder Belt Guide (5b), located at the bottom of the headrest. Make sure the Shoulder belt lays flat and is not twisted (5c).

The seat belt can remain in the Shoulder Belt Clip until the seat is removed from the vehicle.

- 6 Ensure the child is secured correctly, as shown.

Check that the shoulder belt is snug on the child's shoulder and that it does not rub on the neck. It should lie flat across the child's chest and middle of shoulder. The Shoulder Belt Guide should never be below the child's shoulder. If necessary, adjust the Child Restraint Headrest to achieve a proper fit.

SECURING CHILD IN BOOSTER MODE

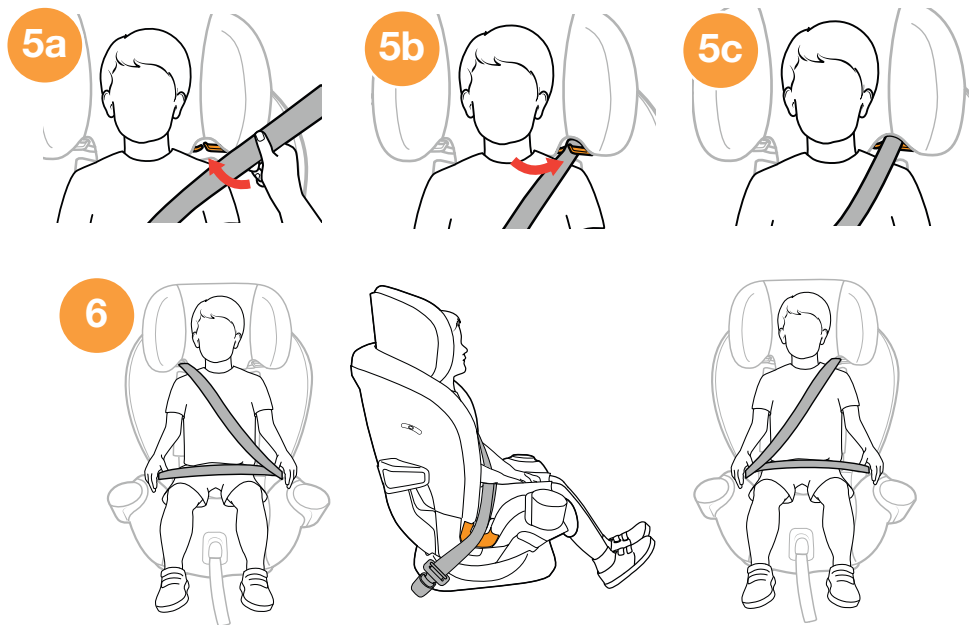

CONVERT TO HARNESS MODE

- 1 To convert the **BOOSTER** back to **REAR FACING** or **FORWARD-FACING** Harness Mode position, lift the top Backrest Seat Pad out of the way. Undo both snap buttons on the lower Backrest Seat Pad and pull forward.
- 2 Lift up on the Harness Straps and slide out the Chest Clips and Buckle tongues.
- 3 Remove the Crotch Strap from the crotch strap compartment. Insert the Crotch Strap into the appropriate opening in seat pad. Make sure the Harness Straps are arranged into the Seat Pad Grooves. Push the seat pad back into place and attach both snap buttons on the lower Backrest Seat Pad. Pull the top Backrest Seat Pad down and push it under the Harness Straps. Re-attach the Shoulder Pads and Crotch Strap Pad.
- 5 Refer to pages 38-39 for Newborn Positioner installation.

CONVERT TO HARNESS MODE

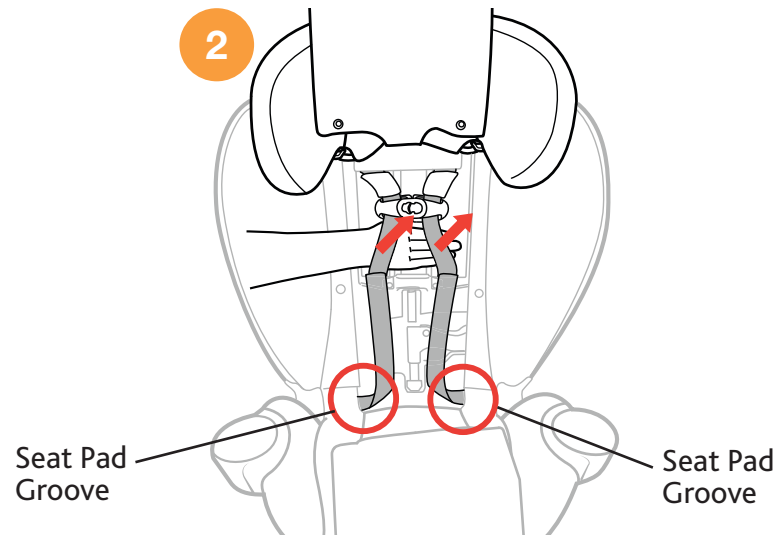

SECURING CHILD CHECKLIST

⚠️ ALWAYS check to make sure vehicle seat belt is securely buckled. If buckle separates, child could be killed or seriously injured.

- ✓ Check that the seat belt is not twisted.

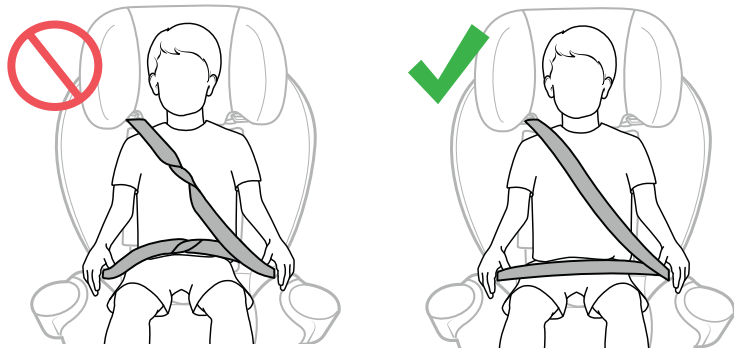

⚠️ **DO NOT** use anything (pillows, blankets, etc.) between the Booster Seat and the vehicle seat or between the child and the Booster Seat. Avoid bulky clothing that interferes with proper seat belt placement. In the event of an accident, the Booster Seat may not operate correctly.

SECURING CHILD CHECKLIST

- ✓ Slide the shoulder belt through the orange Shoulder Belt Guide.
- ✓ Do not let your child slide forward or downward while in the Booster Seat.
- ✓ Never use the vehicle belt in any position other than those indicated in this User Guide!



⚠️ To avoid injury to others, ALWAYS secure this child restraint in BOOSTER MODE when unoccupied. An unsecured Booster Seat could injure other occupants in a sudden stop or crash.

- ✓ Always secure the unoccupied BOOSTER SEAT with either LATCH system (see page 124) or with the vehicle belt by following the "Securing Child in BOOSTER SEAT" instructions, see page 126.

INSTALLATION ON AN AIRCRAFT

When traveling by airplane with your child, Chicco recommends taking the Child Restraint on the airplane with you so that you can use it with your child. Not only will it protect your child during take-off, landing, and turbulence, it will also allow your child to be more comfortable.

- This Child Restraint is certified for use on aircraft in **HARNESS MODE ONLY**. Contact the airline prior to travel to discuss their Child Restraint policy.
- Use this Child Restraint only on FORWARD-FACING aircraft seats.
- Install Child Restraint on an aircraft the same way it is installed in a vehicle when using a vehicle lap belt. Reference Rear-Facing on page 64 or Forward-Facing on page 90.

*This restraint is NOT certified for aircraft use in **BOOSTER MODE**. Aircraft do not have lap-shoulder belts to secure your child.*

PAGE INTENTIONALLY LEFT BLANK

CLEANING AND MAINTENANCE

REMOVING SHOULDER PADS:

- 1** Unhook the hook and loop and remove Shoulder Pads as shown.

INSTALL SHOULDER PADS:

- 2** Re-attach Shoulder Pads by folding the hook and loop Tab over the Harness Strap (a). Secure both hook and loop Tabs together (b). Make sure they are oriented as shown (c).

REMOVING CROTCH STRAP PAD:

- 3** To remove the Crotch Strap Pad, pull the fabric tongue up through the Crotch Strap opening (a). Push the Harness Buckle (b) down into the Crotch Strap Pad and pull it up on the pad (c).

CLEANING AND MAINTENANCE

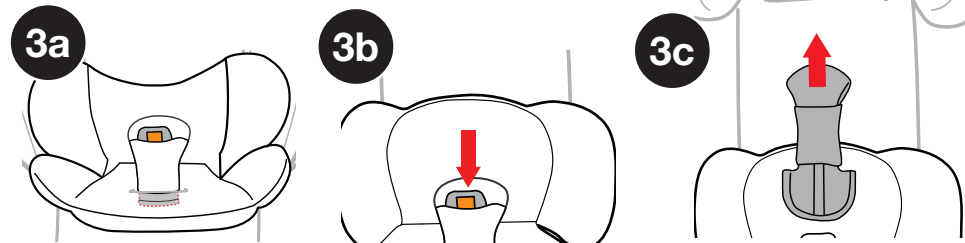
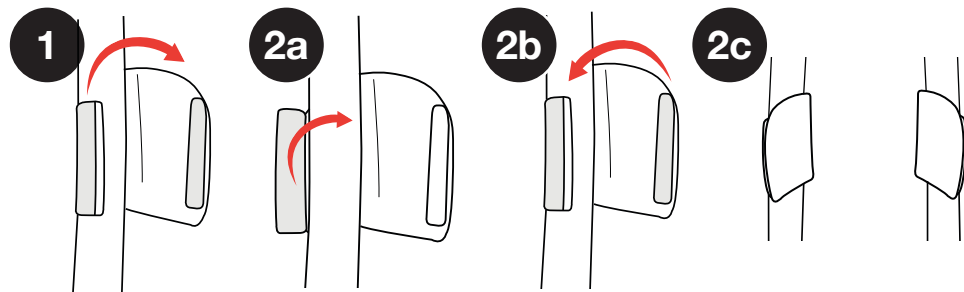

REMOVING CROTCH STRAP:

- 1 Fully recline the seat (position 1). Slide the latch to the right and open the compartment (a). Turn metal bar slightly on underside of seat and get corner to go through slot (b). Push metal bar through slot while pulling crotch belt out (c).

⚠ NEVER use Child Restraint without the Crotch Strap installed.

INSTALL CROTCH STRAP:

- 2 Reverse the removing instructions above to reinstall.

⚠ DO NOT USE Child Restraint if any part of the harness is damaged. For proper removal and installation of the harness straps visit the Chicco website at www.chiccousa.com or call 1-877-424-4226.

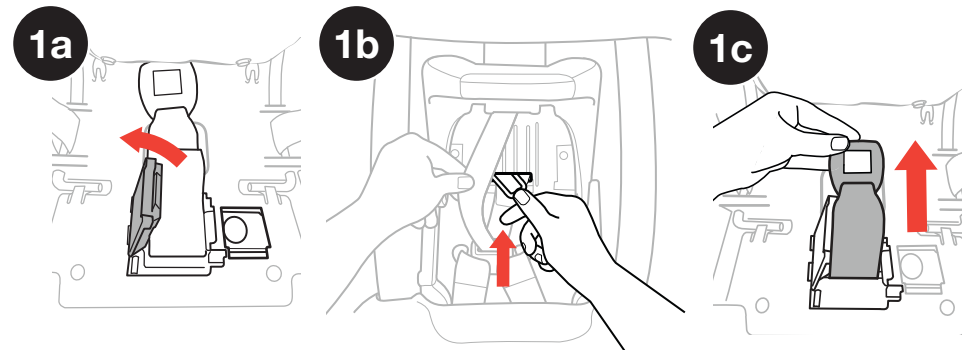

CLEANING AND MAINTENANCE

⚠ DO NOT USE BLEACH, solvents or household cleaners as they may weaken plastics and straps.

⚠ DO NOT USE SOAPS OR LUBRICANTS on Harness Adjuster Strap, Buckle and LATCH hardware. It may cause them to malfunction.

- **Cleaning Softgoods:**

Hand wash using mild soap and water, or machine wash in cold water on delicate cycle using mild detergent. Hang to dry.

⚠ **NEVER** use Child Restraint without the seat pad.

- **Cleaning Shoulder Pads:**

Hand wash using mild soap and water. Hang to dry.

- **Cleaning Plastics:**

Sponge clean using warm water and mild soap. Towel dry.

For softgood removal instructions visit the Chicco website at www.chiccousa.com or call 1-877-424-4226.

CLEANING AND MAINTENANCE

- **Cleaning Cup Holder:**

Cup Holder is dishwasher safe on top rack only.

⚠ **DO NOT USE** Child Restraint if any part of the harness is damaged. For proper removal and installation of the harness straps visit the Chicco website at www.chiccousa.com or call 1-877-424-4226.

- **Cleaning Harness:**

Sponge clean using warm water and mild soap. Air dry. Do NOT machine wash.

- **Cleaning LATCH and Adjuster Strap:**

LATCH Straps cannot be replaced. Sponge clean using warm water only. Air dry.

- **Cleaning Buckle and LATCH Hardware:**

Sponge clean, using warm water only. If debris in buckle, remove and rinse in warm cup of water. Air dry. See page 140 for removal instructions.



Do **NOT** remove LATCH or Adjuster straps. For additional information visit the Chicco website at www.chiccousa.com or call 1-877-424-4226.

[**Kee-Ko**] If you say it right it makes you *smile*



SCAN HERE
LEARN HOW TO
INSTALL & USE
ONEFIT LX

