

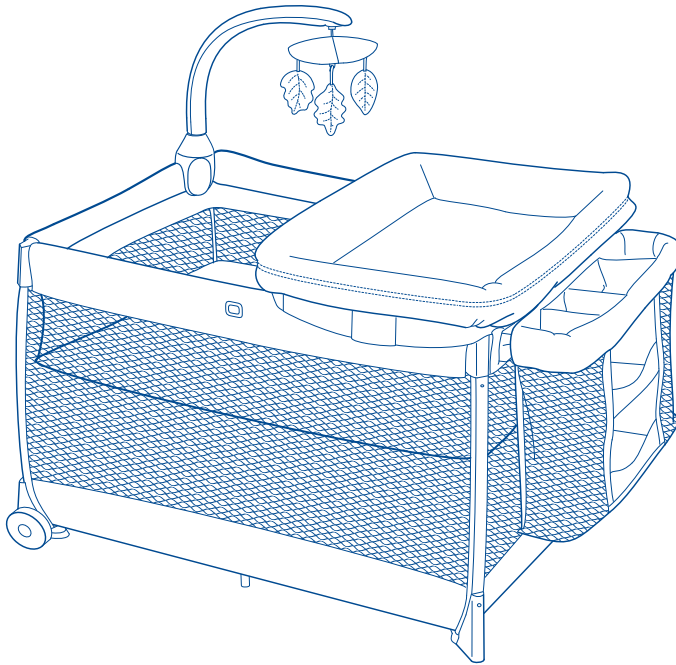

Read all instructions BEFORE
assembly and USE of product.
KEEP INSTRUCTIONS FOR
FUTURE USE.



Lullaby[®] Primo

3-in-1: Bassinet, Playard, Changing Table

Owner's Manual



Failure to follow these warnings and the instructions could result in serious injury or death

- PLEASE READ THESE INSTRUCTIONS CAREFULLY TO ENSURE THE SAFETY OF YOUR CHILD.
 - ALWAYS PROVIDE THE SUPERVISION NECESSARY FOR THE CONTINUED SAFETY OF YOUR CHILD. WHEN USED FOR PLAYING, NEVER LEAVE CHILD UNATTENDED.
 - Playard MUST be fully assembled with all top rails and center floor hub locked into position prior to use or attaching bassinet. Make sure latches are secure.
 - DO NOT place child in playard unless all top rails and center floor hub are securely locked into position and floor pad is in proper place. Infant may roll into space between pad and loose mesh sides causing suffocation.
 - Stop using this product when your child reaches 35 inches (89 cm) in height, weighs more than 30 lbs (14 kg), or is able to climb out.
 - DO NOT use the bassinet when a child is in the playard.
 - FALL HAZARD - To help prevent falls, do not use bassinet when infant begins to push up on hands and knees or weighs over 15 lbs (6.8 kg), whichever comes first.
 - Child can become entrapped and die when improvised netting or covers are placed on top of product. Never add such items to confine child in product.
 - DO NOT use bassinet on a bed, floor or other surfaces.
 - The bassinet is designed for use ONLY with this Chicco Lullaby Primo Playard.
 - Stop using the changing table when your child reaches 25 lbs (11.4 kg).
 - Never use this product if there are any loose or missing fasteners, loose joints, broken parts, or torn mesh/fabric. Check before assembly and periodically during use. Contact Chicco for replacement parts and instruction if needed. Never substitute parts.
 - Although Chicco DOES NOT RECOMMEND refinishing this product, if you choose to refinish, use a nontoxic finish specified for children's products.
- SUFFOCATION HAZARDS - Infants can suffocate:**
- In gaps between extra padding and product side, and
 - On soft bedding.
 - Use ONLY the mattress provided by Chicco. Never add a pillow, comforter, or another mattress for padding.
 - If a sheet is used with the pad, use only a fitted playard sheet specifically designed to fit snug with at least 2" (5 cm) under all sides of the mattress. The sheet must allow proper use of the mattress retention straps.



Failure to follow these warnings and the instructions could result in serious injury or death

- DO NOT leave child in product with any side lowered. Be sure all sides are raised and locked in position whenever child is in product.
 - NEVER use plastic shipping bags as mattress covers. Do not use plastic film as mattress cover unless sold and intended for that purpose. They can cause suffocation.
 - DO NOT use a water mattress with this product.
 - Strings can cause strangulation! DO NOT place items with a string around child's neck (hood strings, pacifier cords, etc.) or attach strings to toys.
 - DO NOT suspend strings into the bassinet or playard.
 - DO NOT place the playard near a window where cords from blinds or drapes can strangle a child.
- OTHER HAZARDS:**
- Keep bassinet and playard away from stoves, heaters, fireplaces and other hazards which can cause injury to your child.
 - To reduce the risk of SIDS (Sudden Infant Death Syndrome), pediatricians recommend healthy infants be placed on their back to sleep unless otherwise advised by a physician.
 - DO NOT place more than one child in bassinet or playard.
 - DO NOT move or fold bassinet or playard with child in it - child could be injured.
- STRANGULATION HAZARDS:**
- NEVER use additional mattresses, padding, sheets, or other objects that will permit your child to climb out, fall and/or be injured. If you choose to ignore this warning, then remove additional padding, large toy, and other objects that could serve as steps for climbing out when your child is able to pull to a standing position.
 - STOP using Bassinet when child can roll over or push up on hands and knees or reaches 15 lbs (6.8 kg), whichever comes first.
 - Strangulation Hazard: Child can lift changing table and get neck trapped between changing table and playard frame.
 - Never leave changing table in place when child is in the playard.

Parts List



A. - Lullaby Primo Frame

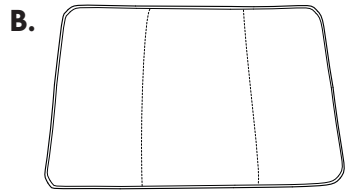

B. - Mattress Pad

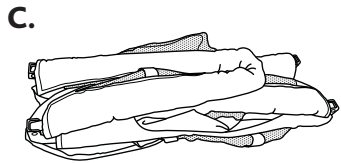

C. - Bassinet

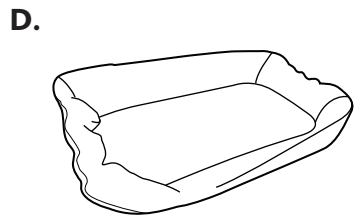

D. - Changing Pad

Parts List

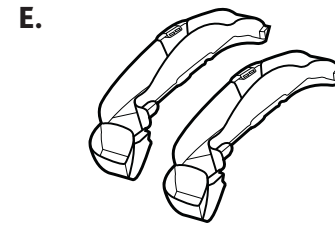

E. - Changing Table Frame Ends

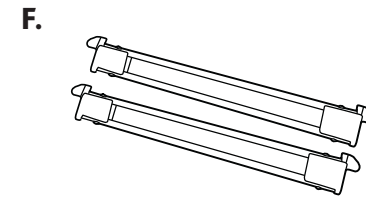

F. - Changing Table Frame Sides

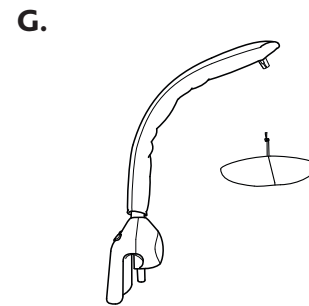

G. - Toy Mobile and Canopy

Parts List

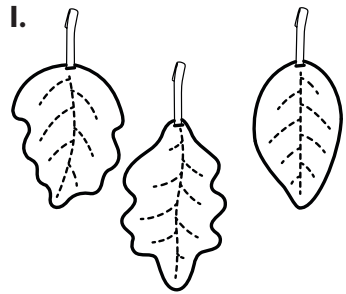

I. - Toys

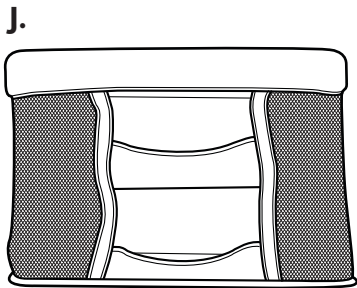

J. - Parent Organizer

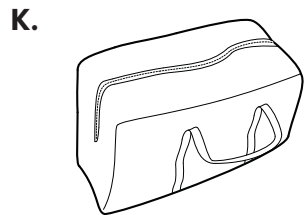

K. - Carry Bag

Setting Up the Playard

⚠ WARNING

Before use remove and dispose of any plastic bags and keep them out of reach of children to avoid the danger of suffocation. Failure to follow these warnings and instructions could result in serious injury or death. Make sure top rails and center floor hub are locked and secure before use. This product requires adult assembly. Keep fingers clear of top corners during setup.

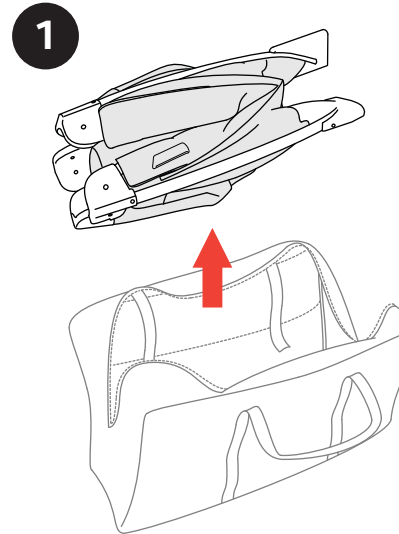

1. Remove Lullaby Primo Frame from the Carry Bag.

Setting Up the Playard

2

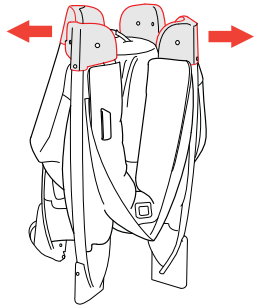

2. With the Lullaby Primo Frame standing upright, pull the corners apart as shown.

If needed, pull up on the center floor hub release strap to lift the floor.

Setting Up the Playard

3

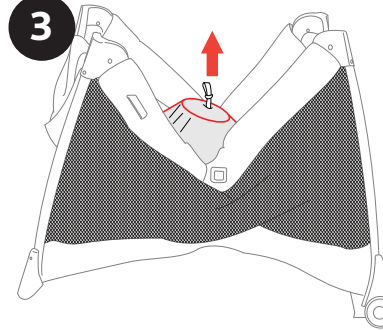

3. The center floor hub must be pulled up to allow the top rails to lock.

With the center hub even (or level) with the 4 corners. Pull up on the top rail center joint to "Click" lock them into their open position. Both sides of the center joint must lock for the top rail to stay open. Repeat for all four top rails.

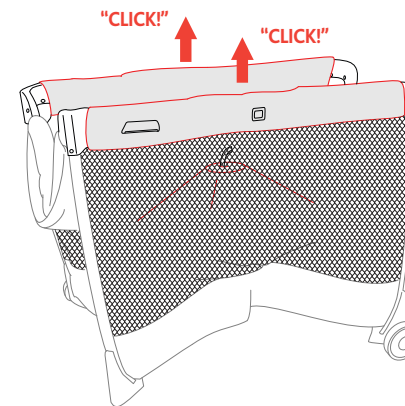

This step is very important for the safety of your child. Make sure the center hub is still pulled up during this step or the side rails will not be able to be latched.

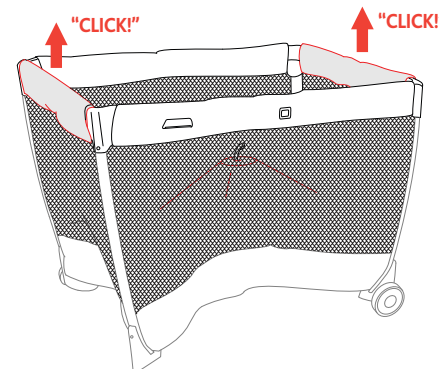

Setting Up the Playard

4

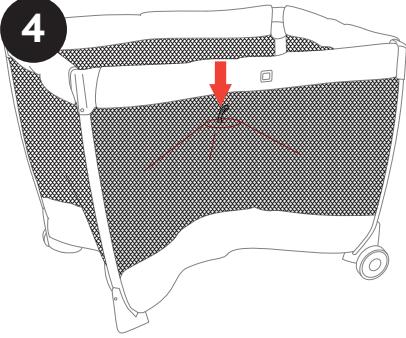

4. Push down on the center floor hub until the bottom of the playard is flat.

For Use as a playard continue to the next step.

For Use as a Bassinet go to step 9 on page 16.

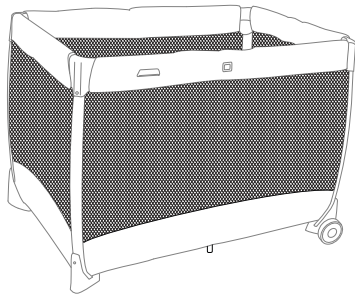
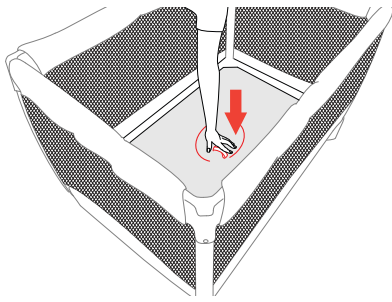

Setting Up the Playard

5

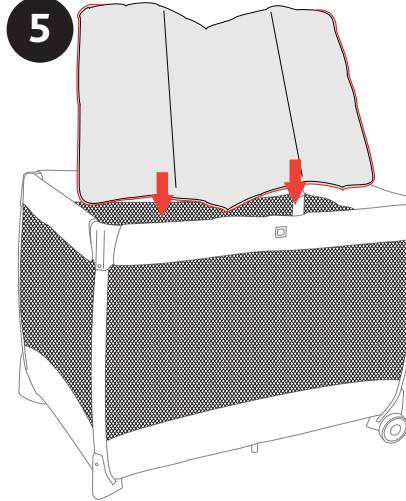

5. Install Mattress Pad, padded side up. Do not use playard without Mattress Pad and make sure to fold hook and loop strap underneath Mattress Pad.

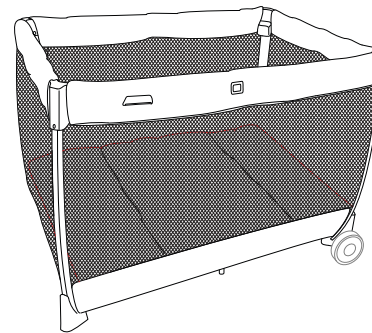

Setting Up the Playard

6

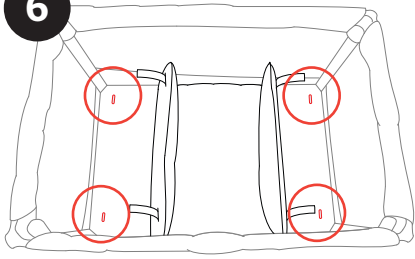

6. Locate 4 Mattress Pad strap holes on the floor of the playard. Thread the 4 hook and loop straps through to the floor of the playard as shown.

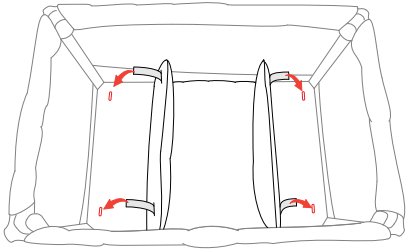

Setting Up the Playard

7

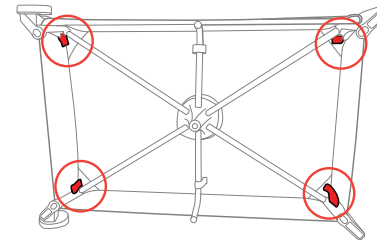
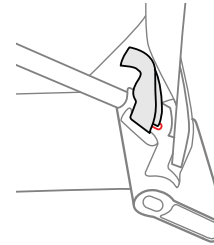
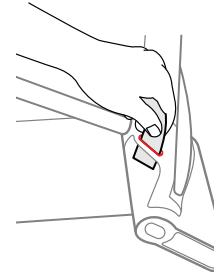
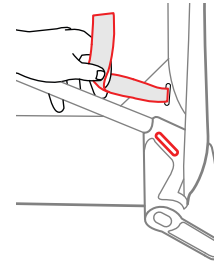

7. Turn the playard on its side and pull the straps through the floor of the playard. Thread the straps through the slot on the playard foot as shown. Pull hook and loop strap tight and then attach together to secure Mattress Pad. Do this for all 4 mattress corners. Pull up on mattress pad to make sure it is secure.

Setting Up the Bassinet

8

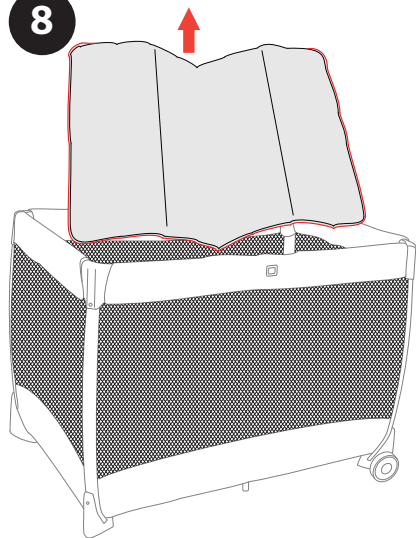

8. Undo the hook and loop straps from the frame and remove Mattress Pad from playard.

Setting Up the Bassinet

9A

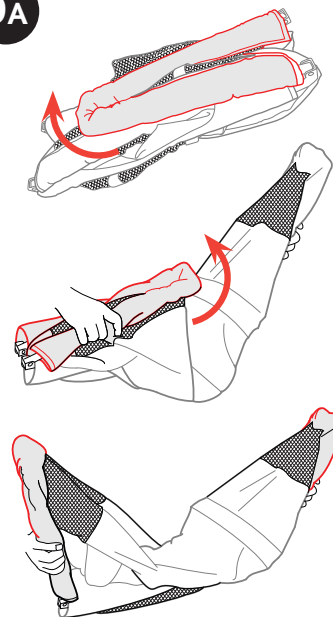

9A. Unfold the Bassinet sides as shown.

Setting Up the Bassinet

9B

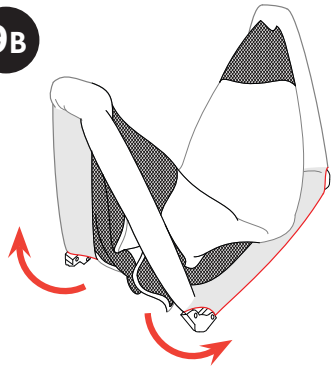

9B. Unfold the Bassinet ends over the playard frame. Fit the 4 corners of the Bassinet over the 4 corner Bassinet Supports on the Lullaby playard as shown 9C. Once the Bassinet is resting on the supports push down on the center joints on the long sides of the Bassinet 9D. This will secure the Bassinet into place. Push down on Bassinet to be sure it is secure.

9C

Bassinet Supports

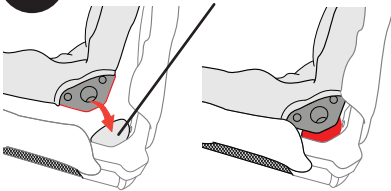

9D

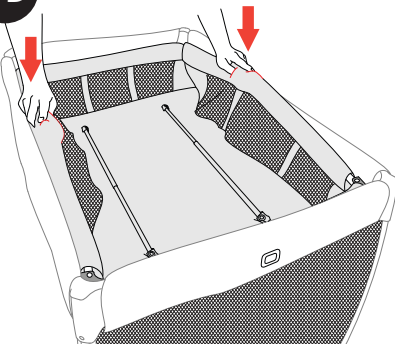

Setting Up the Bassinet

⚠ WARNING

Do not place Bassinet on unit if a child is in the playard. Make sure playard is fully assembled.

10

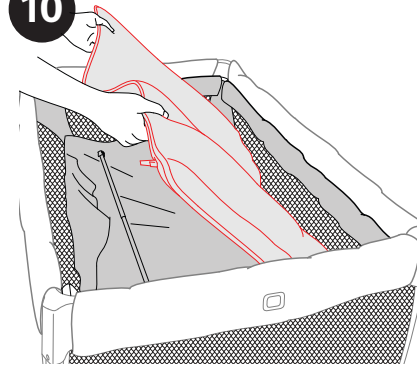

10. The Mattress Pad is slightly larger than the opening of the Bassinet. Do not fully open the Mattress Pad. Insert the Mattress Pad on an angle and slide it towards the side opposite of you. Adjust the mattress to fit the opposite corners before inserting the end closest to you. When the Mattress Pad is fully inserted on the bottom push it firmly into place. This will make the sides taut and remove any slack in the fabric. Always check to make sure the hook and loop straps are folded under the Mattress Pad.

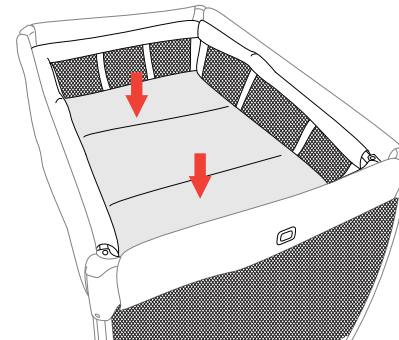

Attaching Parent Organizer

11

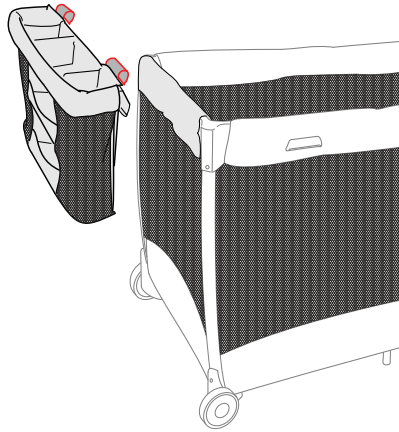

11. Attach the Parent Organizer to the side top rail of the playard as shown.

Parent organizer can be attached to either side. For greater convenience, we recommend the side nearest to the changing table latches.

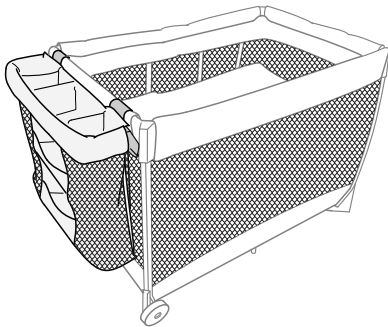

Changing Table Warnings

⚠️ WARNING

FALL HAZARD : Children have suffered serious injuries after falling from changing tables. Falls can happen quickly.

- STAY within arm's reach of your child.
- ALWAYS secure this changing table to the playard frame by attaching to the playard receptacles. See instructions.

SUFFOCATION HAZARD: Babies have suffocated while sleeping on changing tables. Changing table is not designed for safe sleep.

- NEVER allow baby to sleep on changing table.
- Stop using the changing table when your child reaches 25 lbs (11.4 kg).
- Always remove the changing table when your child is in the playard.
- Do not use changing unit if it is damaged or broken.

Assembling Changing Table

12

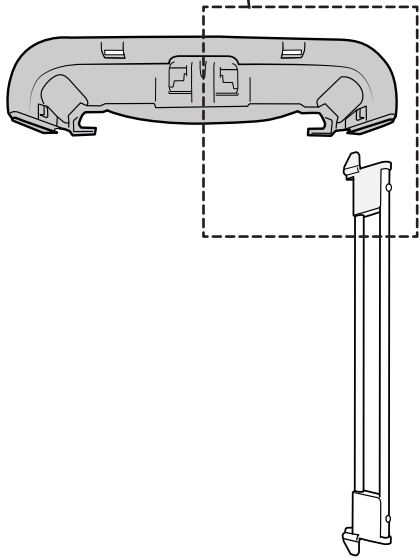
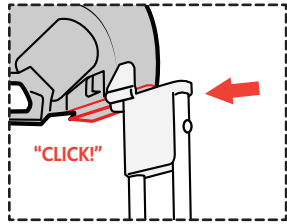
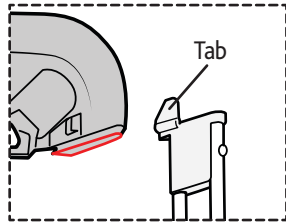

12. Slide the end of the Changing Table Frame Side into the groove of the Changing Table Frame End until it clicks into place. Make sure the tab is on the inside when assembling.

Repeat for the other Changing Table Frame Side as shown.

Do NOT Snap the other end onto the changer frame. Move to step 13 to install softgoods before finishing the changer frame assembly.

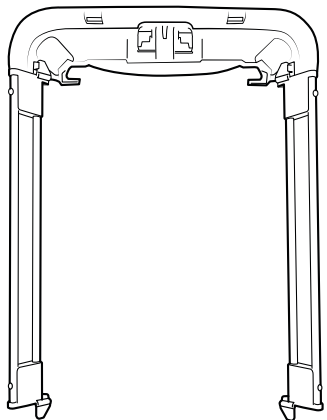

Assembling Changing Table

13A

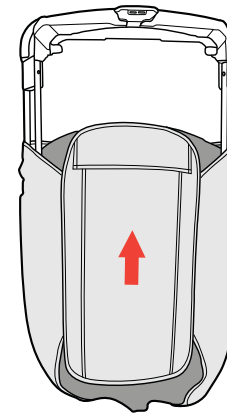

13A. Insert the Changing Table Frame Sides into the openings on the back of the Changing Pad and slide up.

13B



13B. Attach the Changing Table Frame End to the Changing Table Frame Sides as shown making sure it clicks into place.

Assembling Changing Table

14

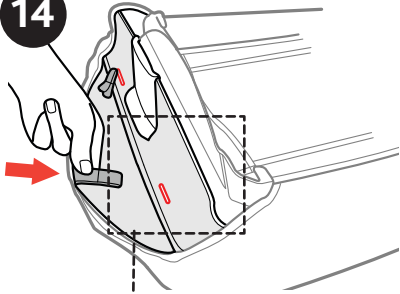

14. Locate the fabric tabs along the outside of the Changing Pad. Thread the fabric tabs through the corresponding openings on the frame and pull the fabric tabs through. Flatten the fabric tabs out to secure them into place. Repeat for both sides.

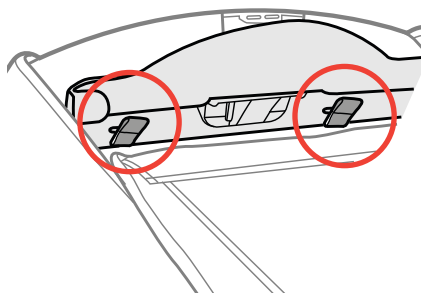
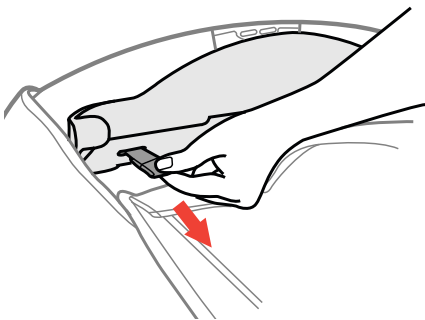
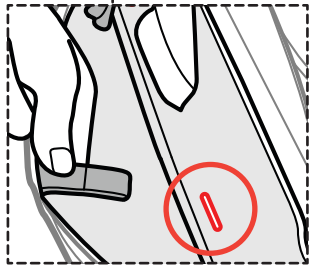

Assembling Changing Table

15

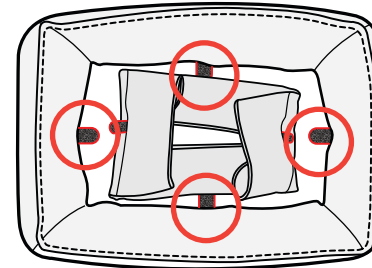

15. Flip the Changing Table right side up. Arrange the Zipper insert so that all 4 of the hook and loop tabs are lined up and connected. Then zip closed both sections of the Zipper Insert.

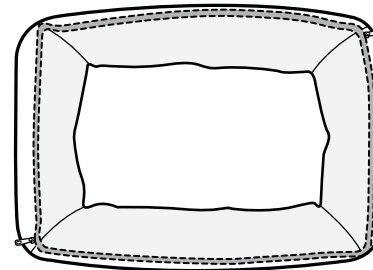
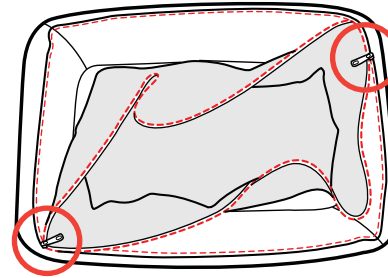

Assembling Changing Table

16

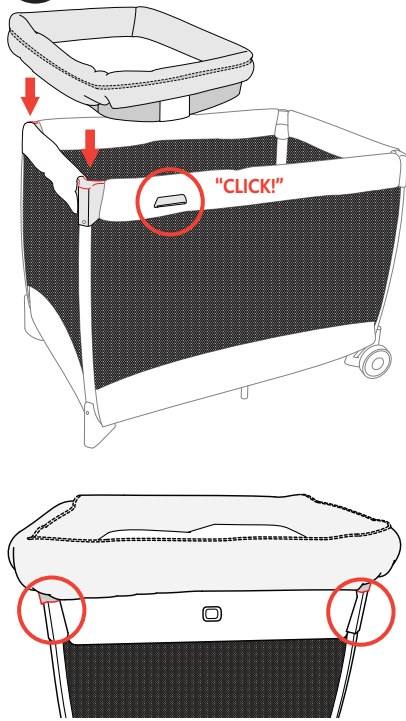

16. IMPORTANT: The Changing Table can only be attached to one end of the playard. Locate the changing table receptacles on the side of the playard. Assemble the Changing Table by lining up the corners of the changing table frame with the corners of the playard. Press down until the changing table latches into the playard receptacles. Pull up on Changing Table to check for attachment. Never use the changer on another surface or playard.

Assembling Changing Table

17

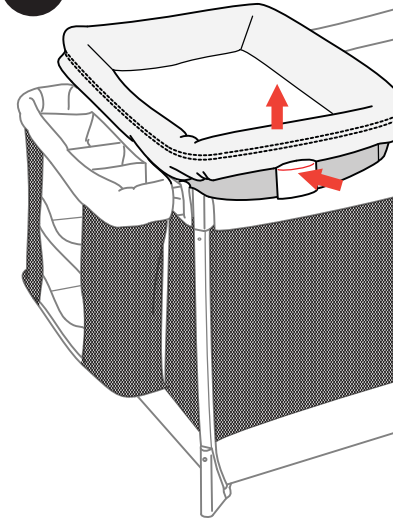

17. Remove the Changing Table by pushing in on the release buttons and lifting up.

Mobile Assembly and Use

⚠️ WARNING

Do not mix old and new batteries. Do not mix alkaline, standard (carbon-zinc), or rechargeable (nickel-cadmium) batteries. Remove batteries before storing this product.

⚠️ WARNING - Recommended use from birth to 5 months. **The Mobile cannot be attached to the playard corner. The Bassinet has to be attached to the playard to use the Mobile.** The mobile is intended for visual stimulation and is not intended to be grasped by the child. Always attach the provided fasteners (strings, straps, clamps, etc.) tightly to mobile and playard according to the instructions. Check frequently for loose or damaged parts. Possible entanglement or strangulation injury. **DO NOT** add additional strings or straps to mobile or playard. Remove toy when baby begins to push up on hands and knees.

Operate Mobile

18

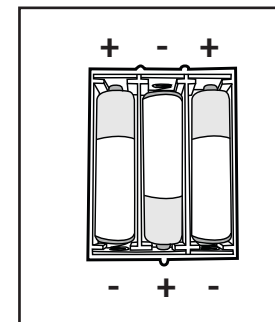
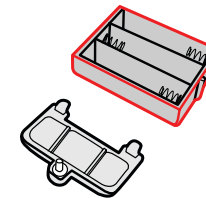
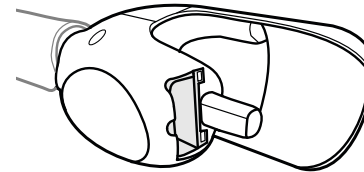
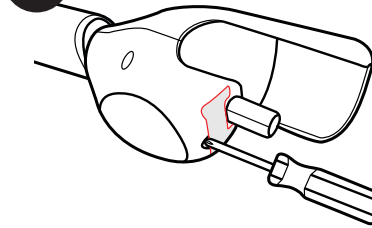

Before attempting to operate the Mobile Arm and Mobile Light, install 3 "AA" batteries in both units.

18. Mobile Arm, use a Phillips screwdriver to unfasten battery cover and remove the battery compartment. Insert the batteries and match the polarity indicated inside battery compartment.

Operate Mobile

19

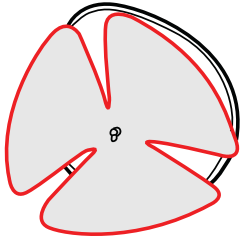

19. Insert the 3 canopy support sections into the fabric sleeve, as shown.

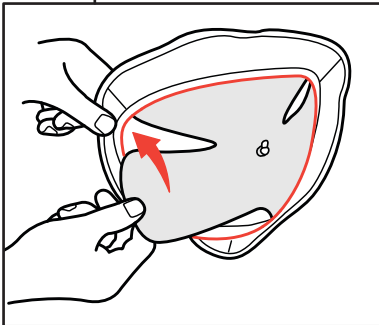
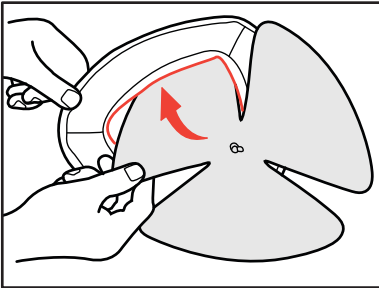

Operate Mobile

20

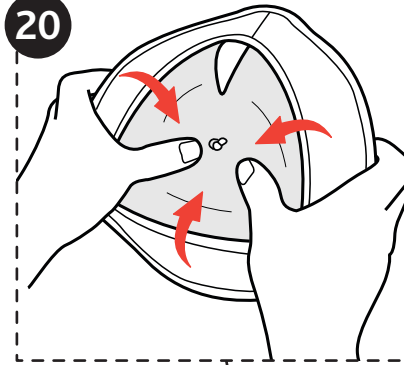

20. Press in on the center of the canopy support to flip it into the fabric sleeve.

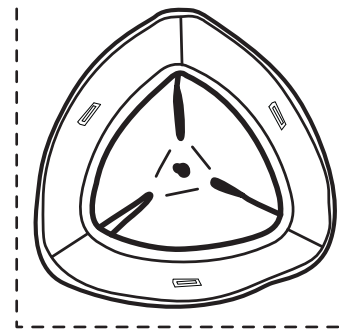

Assembling Toy Mobile

21

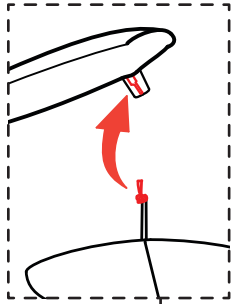

21. Insert the knot at the end of the Toy Mobile canopy string through the opening at the top of the Toy Mobile Arm, as shown. Pull on the fabric to secure the string.

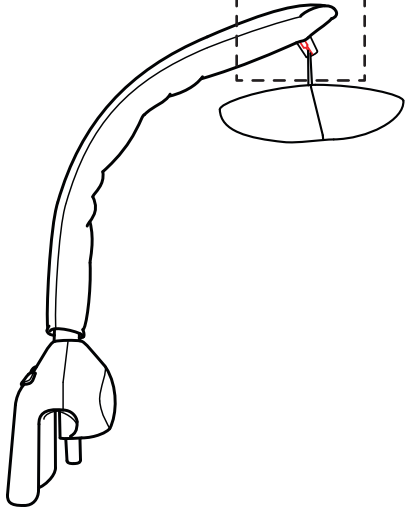

Assembling Toy Mobile

22

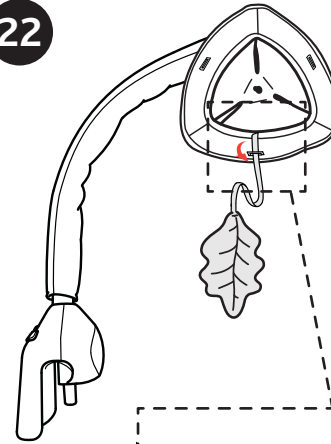

22. Slide the Toy strap through the opening on one of the sides of the Toy Mobile. Fold the hook and loop strap together to secure the toy. Repeat for the remaining 2 Toys.

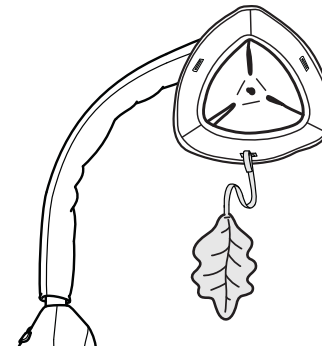
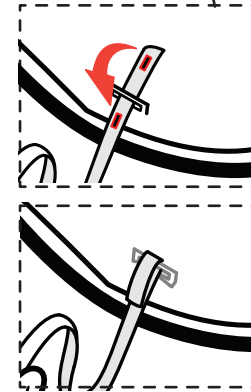

Assembling Mobile

23

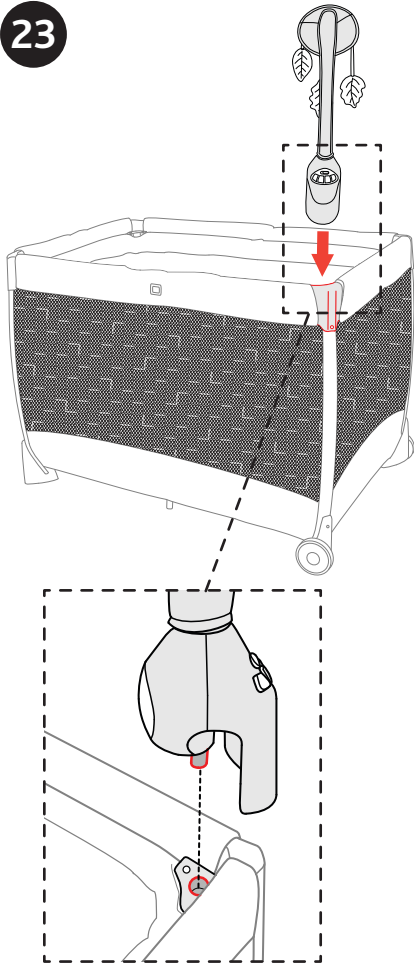

23. Attach the Mobile by sliding the base down over any of the playard corners with the Bassinet attached. Line up the post with corresponding Bassinet corner slot and push down until the Mobile base is completely seated around the corner of playard.

Assembling Mobile

24

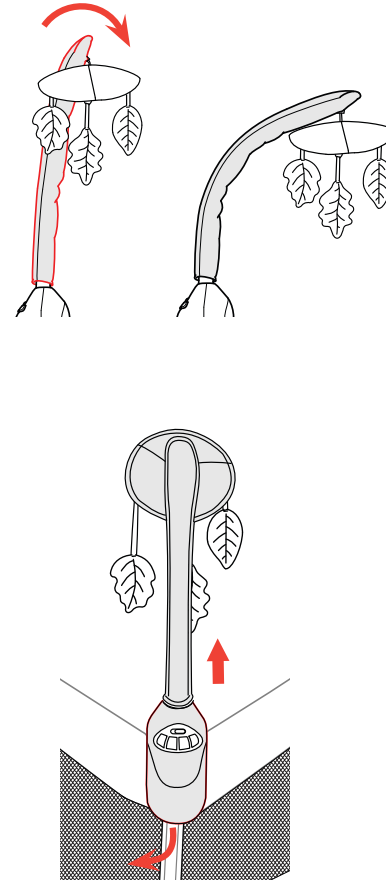

24. The curve of the Mobile Toy bar can be adjusted as shown. To remove the Mobile base pull out to release the bottom edge of the Mobile base and pull up.

Operate Mobile

25

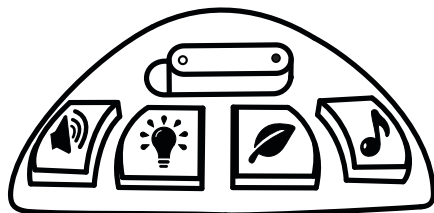

25. Slide the switch to the left to turn the mobile "ON". Slide the switch to the right to turn "OFF" the mobile.

VOLUME: Press the Volume (🔊) button to cycle through 3 volume settings: Low, Medium, High.

LIGHT: Press the LIGHT (💡) button to turn the Lights "ON" or "OFF". When the light is "ON" it will automatically turn off in 10 minutes.

NATURE SOUNDS: Press the Nature Sounds (🌿) to cycle through 4 different sounds of nature. The selected Nature Sound will play for a 10 minutes then automatically turn off.

MUSIC: Press the Music (🎵) button to cycle through 8 different melodies. Select a starting melody, all 8 melodies will cycle through twice, starting with the first melody selected. To Lock in a melody and have it repeat 10 times, select a melody and press and hold the Music (🎵) Button for 2 seconds.

Packing Up the Playard

26

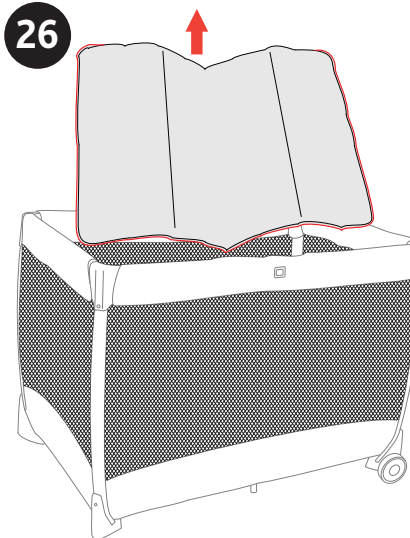

26. Remove the Bassinet, Toy Mobile, Parent Organizer, Changing Table and Mattress Pad. Pull up on the center floor hub release strap and lift the center hub up as far as possible.

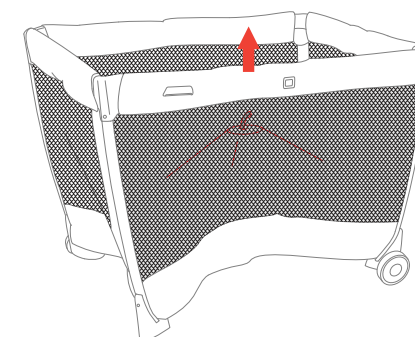
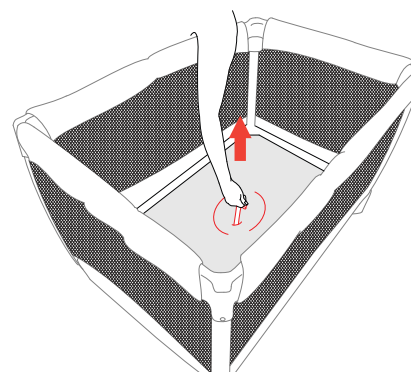

Packing Up the Playard

27

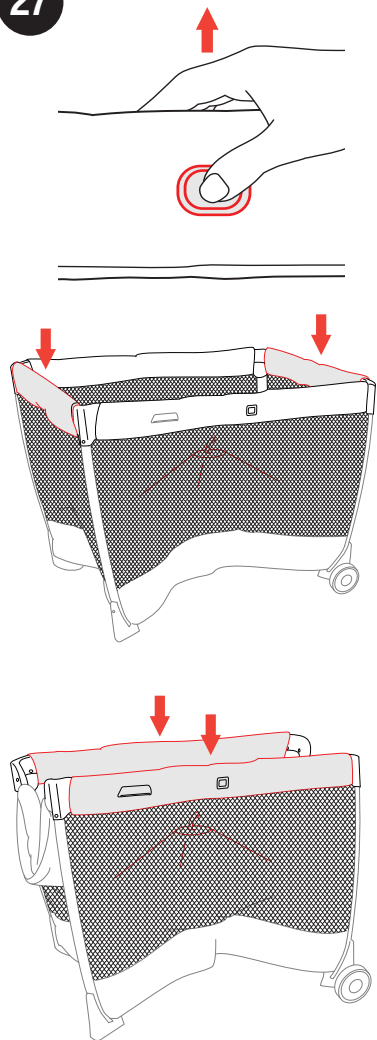

27. Lift and squeeze the Top Rails center release lock, then push down. Release all of the Top Rail locks on all 4 sides. If the Top Rail does not unlock pull up on the center hub to release the floor locks. Center floor hub must be even with top rails.

Packing Up the Playard

28

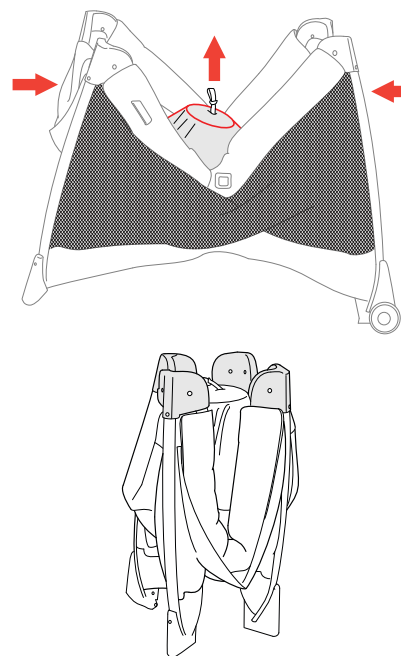

28. Pull up on the center floor hub release strap and pull the playard legs towards the center.

Packing Up the Playard

29

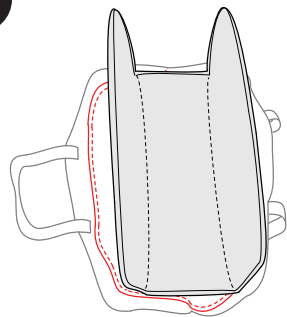

29. Place the Mattress Pad into the Carry Bag - Make sure the padded side of the mattress pad is facing up. Then place the folded playard into the Mattress Pad. Place all other accessories on top.

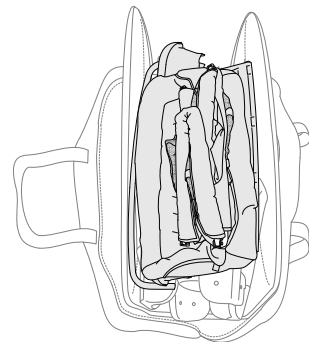
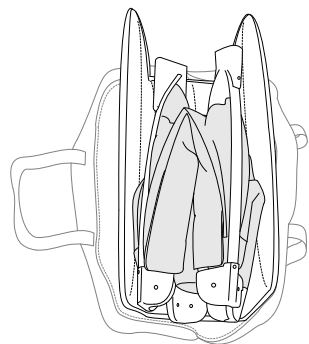

Packing Up the Playard

30

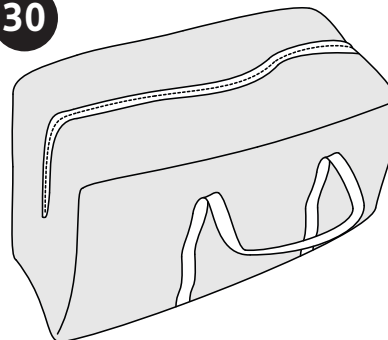

30. Pull up the sides of the Carry Bag and close the zipper.

Packing Up the Playard

31

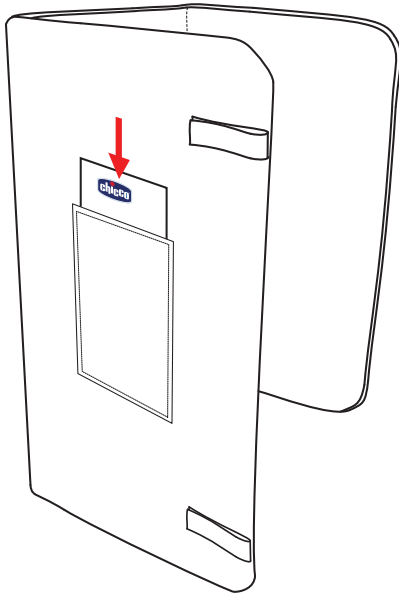

31. To keep instructions for future use: Place the manual in the storage sleeve located on the underside of the Mattress Pad.

Fitting and/or Replacing Batteries

⚠️ WARNING

The Electronic Play Tray requires 3 x "AA" 1.5 Volt alkaline type batteries (not included).

- Batteries must only be fitted by an adult.
- To fit and/or replace batteries: Loosen the screw on the battery compartment cover with a suitable screwdriver, press the tab and remove the battery compartment cover. Then remove the spent batteries and fit new ones, ensuring that they have been fitted in the correct polarity, as shown inside the battery compartment. Replace the battery cover and tighten the screw.
- Always keep batteries and tools out of reach of children.
- Always remove spent batteries from the Mobile to avoid the danger of possible leakage from the battery.
- Always remove the batteries if the Mobile will not be used for a long period.
- Only use alkaline batteries of the same type or equivalent to the type recommended for the correct function of this product.
- Never mix new and old batteries, or different types of batteries.
- Do not burn or dispose of spent batteries into the environment. Dispose of spent batteries at an appropriate differentiated collection point.
- Do not short-circuit the battery terminals.
- Do not attempt to recharge non-rechargeable batteries: they might explode.
- The use of rechargeable batteries is not recommended, since they could impair the functionality of the Mobile.
- If rechargeable batteries are used, take them out of the toy before recharging them. Batteries must always be recharged under adult supervision.

Trouble Shooting Guide

TOP RAILS FAIL TO LOCK INTO AN UPRIGHT POSITION :

Before top rails can be locked, the center floor hub must be pulled up as high as the 4 corners. If needed, pull up on the center floor hub release strap. If necessary, pull the release strap up with one hand and lock rails one at a time. If you are still unable to lock the top rails, call Chicco Customer Service (pg. 47).

THE FLOOR JOINTS DO NOT FLATTEN:

Turn playard upside down and make sure joints are free from foreign objects.

TOP RAILS DO NOT UNLOCK TO FOLD:

Lift top rail first, then squeeze to release. Before top rails can be unlocked, the center floor hub must be pulled up. If needed pull up on the center floor hub release strap as high as the 4 corners.

FLOOR JOINTS DO NOT UNLOCK:

Pull up on the center floor hub release strap to unlock floor joints.

FOLDED PLAYARD DOES NOT FIT INTO MATTRESS PAD:

Pull up on the center floor hub release strap and gather playard legs towards the center to make the playard more compact. If necessary, shift playard lower on pad or turn slightly and try again.

BASSINET DOES NOT FIT ONTO PLAYARD:

Playard top rails must be fully upright and locked. Playard floor must be flat.

LULLABY PRIMO MOBILE DOES NOT FIT INTO CORNER SLOT:

Make sure fabric is not covering the slot in the bassinet corner. The mobile will fit onto any of the corners - Try another corner.

Cleaning and Maintenance

This product requires regular maintenance. The cleaning and maintenance of the playard must only be carried out by an adult.

The mattress cover and changer insert can be washed, remove the boards from the mattress cover as shown.

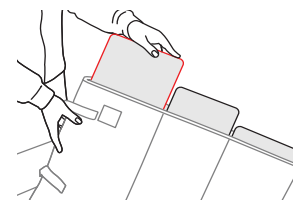

Locate the zipper on the mattress cover and unzip. Remove all of the floor boards and set them aside.

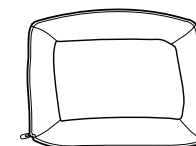

Undo the zippers and remove the Changer Insert.

Do not immerse the wooden boards in water. Wipe clean with a damp cloth and mild detergent (do not use bleach).

CLEANING

Please refer to the care label for instructions on cleaning the fabric parts of the playard.

Periodically wipe clean plastic parts with a soft damp cloth. Always dry the metal parts to prevent the formation of rust if the playard has come into contact with water.

MAINTENANCE

Periodically check the playard for loose screws, worn parts, torn material or stitching. Replace or repair the parts as needed. Use only Chicco replacement parts. Keep the playard in a dry place. If playard becomes wet open playard and allow to dry completely. Prolonged exposure to direct sunlight may cause the fabric to fade and plastic parts to warp.

For More Information

If you have any questions or comments about this product, or are missing any of the parts please do not return this product to the store. Contact us in one of the following ways:



(877)-424-4226



info.usa@artsana.com



www.chiccousa.com



1826 William Penn Way
Lancaster, PA 17601

FCC Information

Warning: Changes or modifications not expressly approved by the party responsible for compliance could void the user's authority to operate the equipment.

NOTE: This equipment has been tested and found to comply with the limits for a Class B digital device, pursuant to Part 15 of the FCC Rules. These limits are designed to provide reasonable protection against harmful interference in a residential installation. This equipment generates, uses and can radiate radio frequency energy and, if not installed and used in accordance with the instructions, may cause harmful interference to radio communications. However, there is no guarantee that interference will not occur in a particular installation. If this equipment does cause harmful interference to radio or television reception, which can be determined by turning the equipment off and on, the user is encouraged to try to correct the interference by one or more of the following measures:

- Reorient or relocate the receiving antenna.
- Increase the separation between the equipment and receiver.
- Connect the equipment into an outlet on a circuit different from that to which the receiver is connected.
- Consult the dealer or experienced radio/TV technician for help.



www.chiccousa.com