

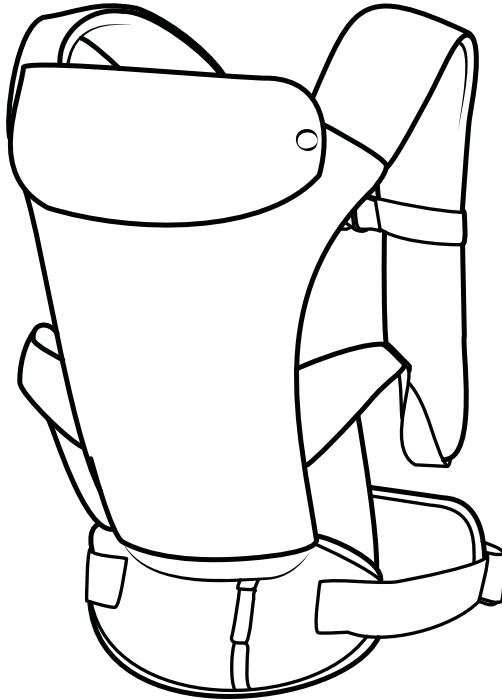

Read all instructions BEFORE
assembly and USE of product.
KEEP INSTRUCTIONS FOR
FUTURE USE.



SnugSupport™

Convertible Baby Carrier

Owner's Manual



Failure to follow these warnings and the instructions could result in serious injury or death

FALL AND SUFFOCATION HAZARD

•**FALL HAZARD** - Babies can fall through a wide leg opening or out of carrier.

- Before each use, make sure all buckles, snaps, straps, and adjustments are secure.
- Take special care when leaning or walking.
- Never bend at waist; bend at knees.
- Only use this carrier for babies between 7.5 lbs (3.4 kg) to 33 lbs (15 kg).

•**SUFFOCATION HAZARD** - Babies under 4 months can suffocate in this product if face is pressed tight against your body.

- Do not strap baby too tight against your body.
- Allow room for head movement.
- Keep baby's face free from obstructions at all times.
- If you nurse your baby in carrier, always reposition after feeding so baby's face is not pressed against your body.

- Baby must face towards you until he or she can hold head upright.
- Do not use carrier in the back position with a baby weighing less than 16 lbs (7.3 kg) or more than 33 lbs (15 kg).
- The baby carrier must only be worn by an adult.
- Always properly fit the carrier on you before sitting the baby in it.
- Ensure proper placement of baby in product including leg placement.
- Ensure that you are holding baby safely in your arms.
- Premature infants, infants with respiratory problems, and infants under 4 months are at greatest risk of suffocation.
- It is recommended that you place the baby in the carrier while sitting. Always make sure the baby is securely supported when placing the baby in the carrier.
- Check for ripped seams, torn straps or fabric and damaged fasteners before each use.



Failure to follow these warnings and the instructions could result in serious injury or death

- Never use a soft carrier when balance or mobility is impaired because of exercise, drowsiness, or medical conditions.
 - Use the carrier only while standing or walking.
 - Never use a soft carrier while engaging in activities such as cooking and cleaning which involve a heat source or exposure to chemicals.
 - While using carrier be aware that your balance may be adversely affected by baby's movement.
 - This carrier is not suitable for use during sporting activities.
 - Do not leave your baby unattended inside the carrier if you are not carrying it on your shoulders.
 - Do not use the carrier to hold your baby in a vehicle, in place of a car seat.
 - Never wear a soft carrier while driving or being a passenger in a motor vehicle.
 - Do not seat more than one baby at a time in the carrier.
 - Do not attach any parts to the carrier that are not supplied or expressly approved by Chicco.
- Before use, remove and dispose of plastic bags and other packaging materials, and keep them out of reach of babies and children.

Infant Carrier Components

- A. Head Support
- B. Shoulder Strap
- C. Carrier Body
- D. Adjustable Leg Supports
- E. Waist Supports with Accessory Loops
- F. Shoulder Strap Support - Height Adjustment
- G. Shoulder Strap Support Buckle and Adjustment Strap
- H. Shoulder Adjustment Strap
- I. Waist Belt Buckle and Adjustment Strap

Infant Carrier Components

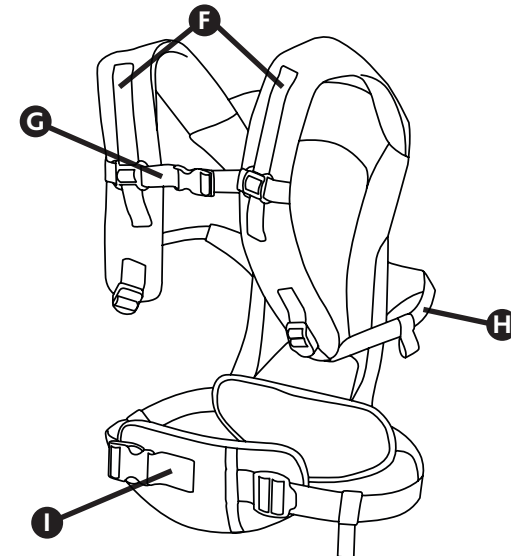
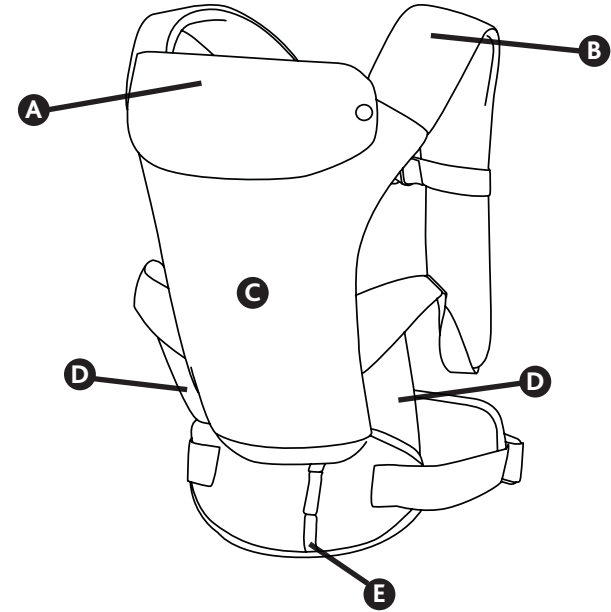

Choose Carrying Position

⚠️ WARNING

It is recommended that you place the baby in the infant carrier while sitting. Always make sure the baby is securely supported when placing the baby in the carrier.

4 carrying positions

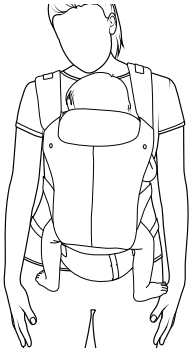

Parent-Facing Narrow Seat

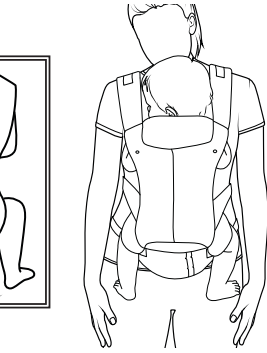
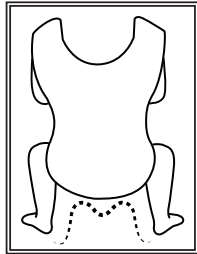

Parent-Facing Wide Seat

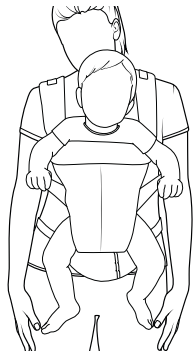

Outward-Facing Narrow Seat



Back Carry

The Infant Carrier can be used for a baby from 7.5 lbs (3.4 kg) to 33 lbs (15 kg). With a Natural Ergonomic "M" seat position for Parent-Facing positions. Before fitting the baby in the infant carrier, make sure that you have completed the following steps correctly.

Adjust for Child Fit

Expand the Adjustable Leg Supports for knee-to-knee support:
Narrow for smaller baby or Wide for larger baby.

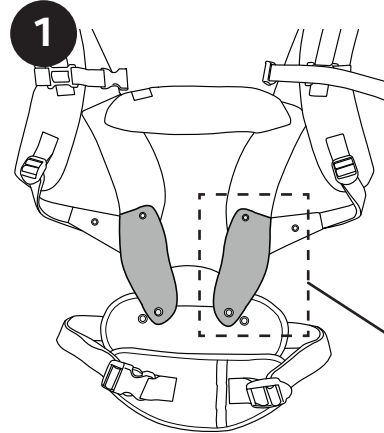

Narrow Seat

1. To adjust, undo the top and bottom snap buttons to fold or unfold the Adjustable Leg Supports. Re-attach both snap buttons. Make sure both sides are in the same position.

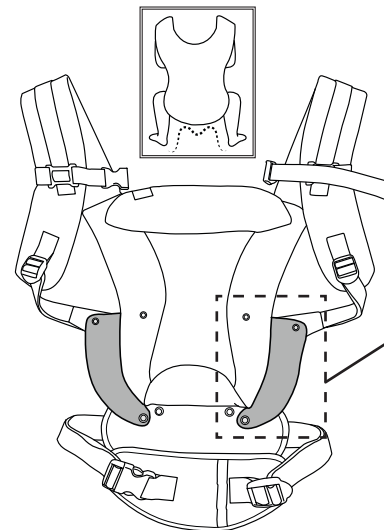
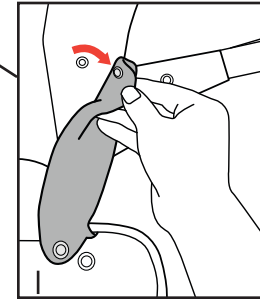

Wide Seat

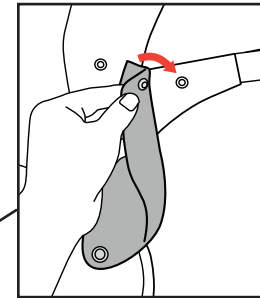

Adjust for Child Fit

2

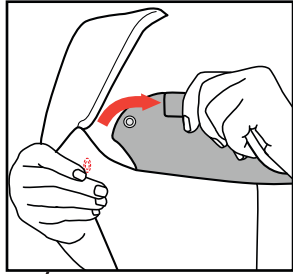

2. For the Outward-Facing position, you will need to fold down the Head Support fabric. Undo both snap buttons on each side. Fold down the Head Support and re-attach both snap buttons on the outside of the infant carrier.

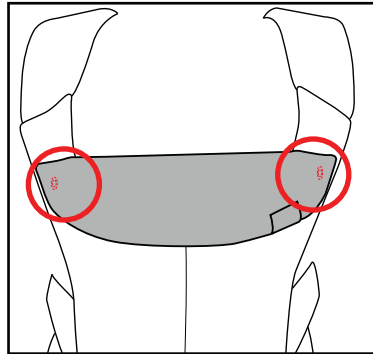
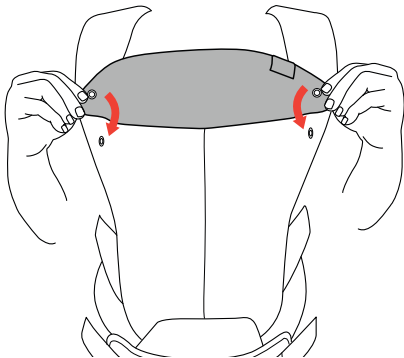
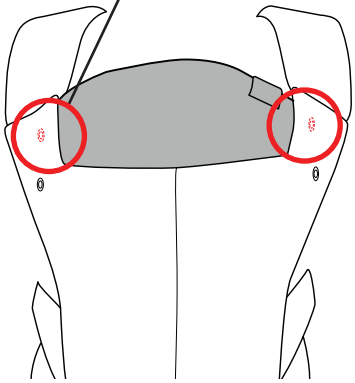

Parent Fit and Strap Adjustments

3

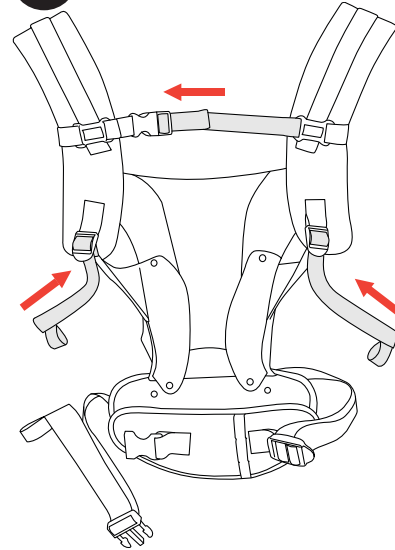

3. Fit the Infant Carrier to your shoulders before placing the baby in the Infant Carrier.

Loosen the Shoulder Strap Buckles and Back Buckle adjustment strap. Adjust the Back Buckle up or down to better fit your body and make sure that both sides are at the same level.

For Parent-Facing positions, Shoulder Strap Support Buckle should be positioned high on your shoulders, making it easy to reach and buckle, and also keeping the Shoulder Straps securely positioned on your shoulders.

For Outward-Facing, the Shoulder Strap Support Buckle can be positioned lower on the Shoulder Straps for a comfortable fit across your chest.

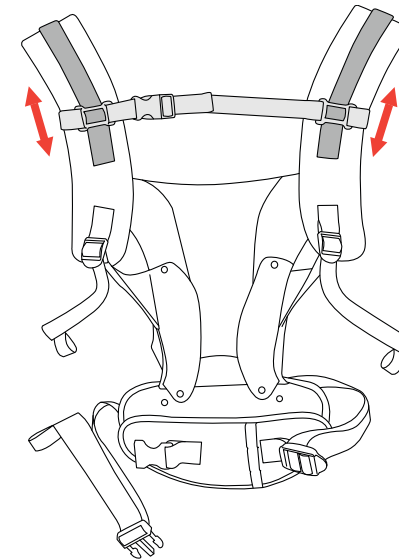

Parent Fit and Strap Adjustments

4A

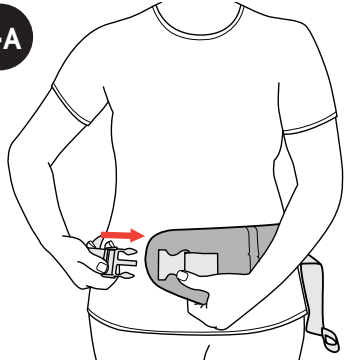

The position of the waist belt on your body is adjustable and determined by the height of your baby.

4A. Wrap the Infant Carrier Waist Belt around your waist and buckle the Waist Belt Buckle. Position the belt higher or lower so that your baby's head is just below your chin when baby is inside Carrier.

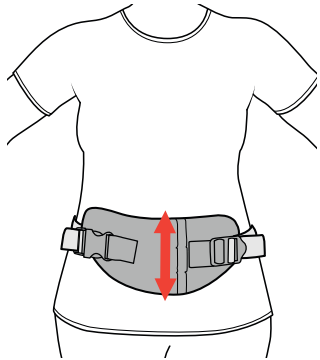

Parent Fit and Strap Adjustments

4B

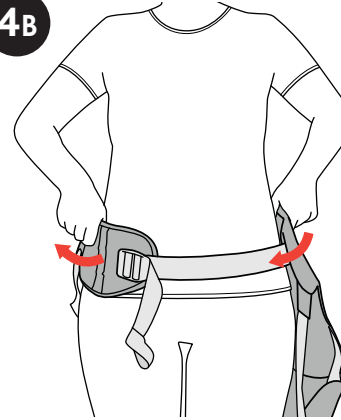

4B. Rotate the Infant Carrier Waist Belt around until the infant seat is at the front of your waist. Adjust both Waist Adjustment Straps to tighten the waist belt.

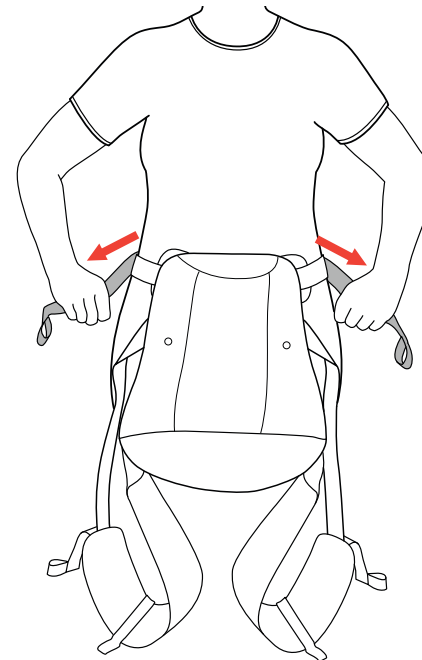

Parent Fit and Strap Adjustments

5

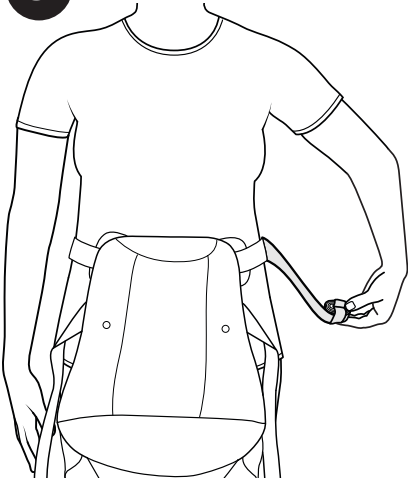

5. Locate the elastic loop attached to the ends of the waist belts. After proper adjustments, roll up the excess length of strap from the bottom up and secure it with the elastic loop, as shown.

Parent Fit and Strap Adjustments

6

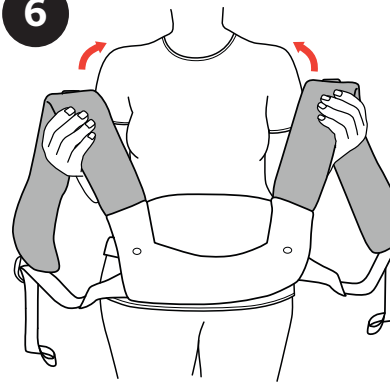

6. Place both Shoulder Straps onto your shoulders and buckle the Back Buckle. Pull on the adjuster strap to tighten the Shoulder Strap Support Buckle.

If the Infant Carrier does not fit properly, re-adjust the position of the Shoulder Strap Support Buckle or adjustment straps until it fits correctly.

This completes primary adjustments. You are now ready to fit the baby to the carrier.

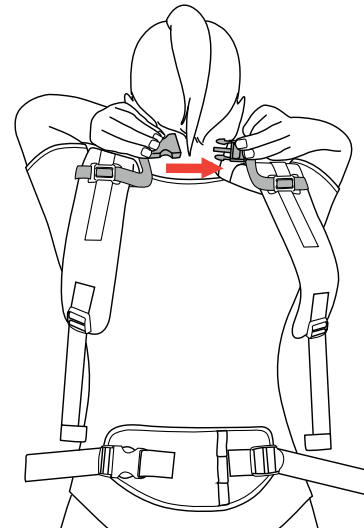

Infant Carrier Use

⚠️ WARNING

FALL HAZARD - Babies can fall through a wide leg opening or out of carrier.

Hold your baby safely while completing this operation. Ensure that the baby's legs are positioned correctly, straddling the Carrier.

7A

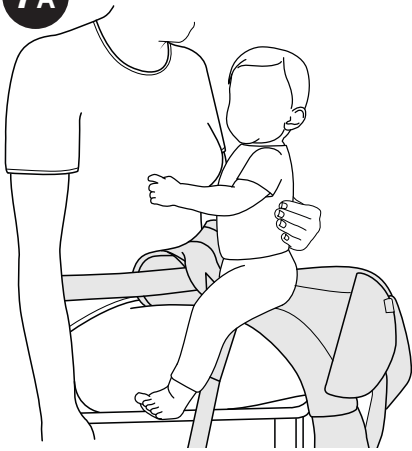

Complete steps 4 thru 6, attaching and adjusting carrier to your waist before placing your baby in the carrier.

7A. PARENT-FACING POSITIONS: Place the baby in your lap. While securely holding your baby, pull the carrier up around the baby. Place both shoulder straps over your shoulders.

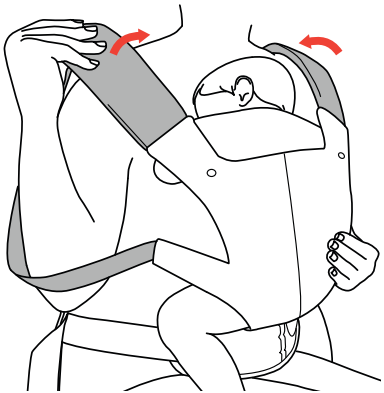

Infant Carrier Use

7B

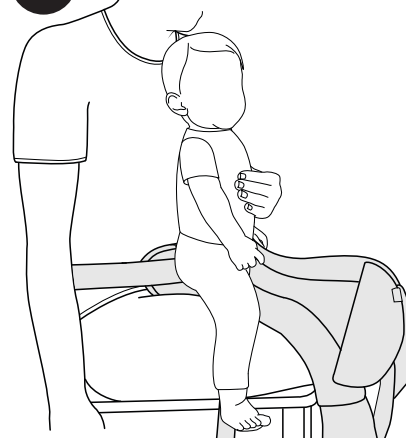

7B. OUTWARD-FACING POSITIONS: Place the baby in your lap. While securely holding your baby, pull the carrier up around the baby. Place both shoulder straps over your shoulders. Make sure to fold down the Head Support fabric (see step 2).

Infant Carrier Use

8

8. Attach the Shoulder Strap Support Buckle and snug the adjuster strap as shown.

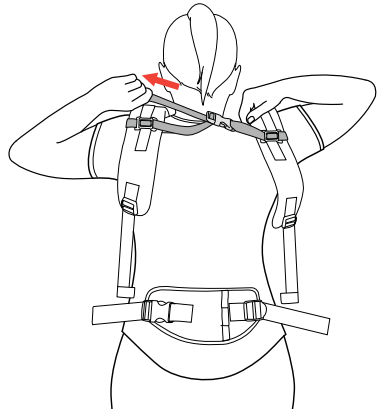
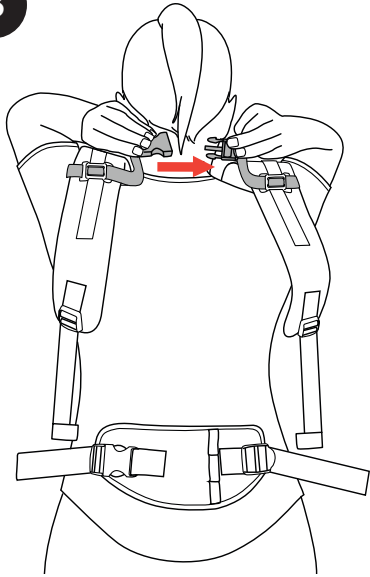

Infant Carrier Use

⚠️ WARNING

Ensure that the area around the baby's face is unobstructed and provides ample air circulation.

9

9. Snug the Shoulder Adjuster straps, one at a time by pulling straps forward towards Carrier Body.

Elastic loop rolls are attached to the ends of the Shoulder Adjuster straps. After proper adjustments, the end of the shoulder belts can be rolled and secured with the elastic loops.

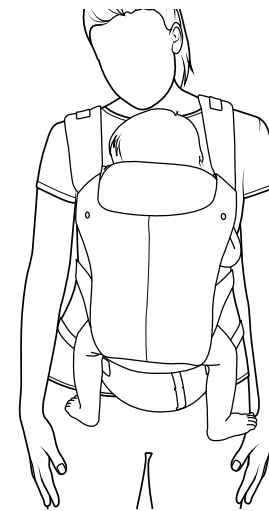
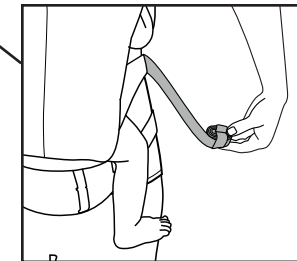
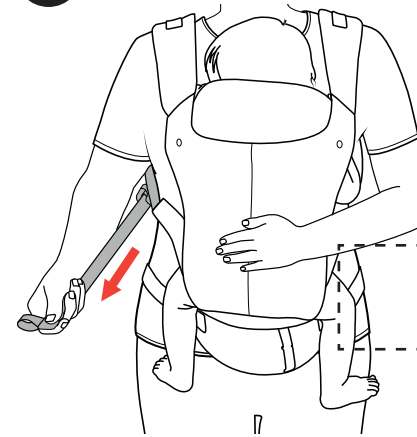

Infant Carrier Use

10

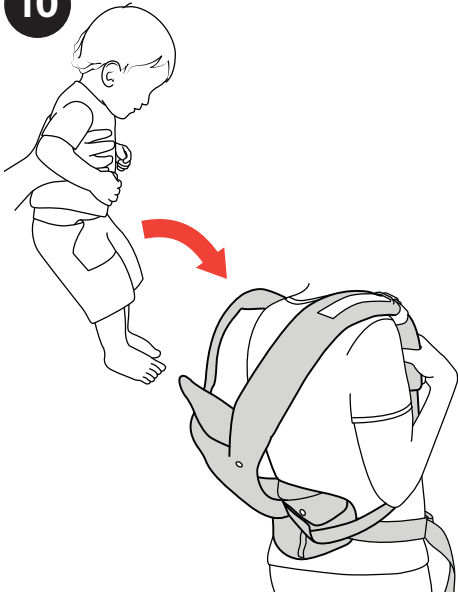

10. BACK CARRY POSITION: Secure the Carrier to your waist and shoulders using both Buckles. Loosen the Shoulder Strap length to give enough room to place your baby in the carrier. With the help of another adult, place your baby into the Carrier. Guide both of the baby's feet below the Shoulder Straps. Make sure your baby is securely seated and comfortable in the Carrier, as shown.

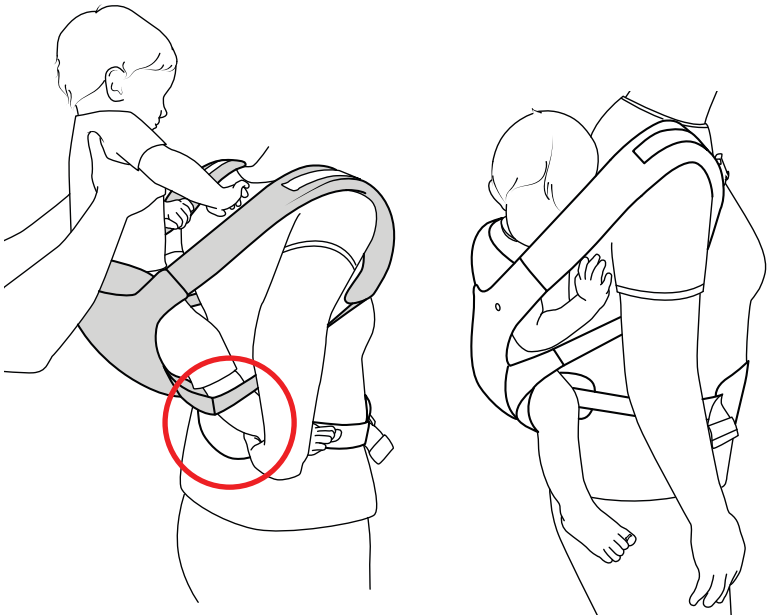

Infant Carrier Use

11

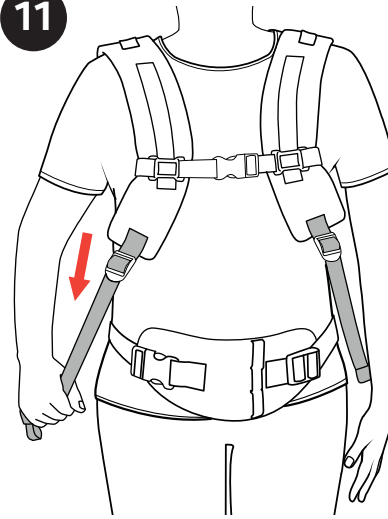

11. Snug the Shoulder Adjuster straps, one at a time by pulling straps down.

Elastic loop rolls are attached to the ends of the shoulder belts. After proper adjustments, the end of the Shoulder Adjuster straps can be rolled and secured with the elastic loops (see step 9).

Cleaning and Maintenance

Spot clean with damp cloth and mild, soapy water. Or hand wash only in warm soapy water. Air dry. After each washing check that the fabric and seams are not worn or damaged. If any part is worn or missing, do not use this product.

For More Information

For USA customers:

If you have any questions or comments about this product, or are missing any of the parts, please do not return this product to the store. Contact us in one of the following ways:



(877)-424-4226



info.usa@artsana.com



www.chiccousa.com



1826 William Penn Way
Lancaster, PA 17601



www.chiccousa.com